

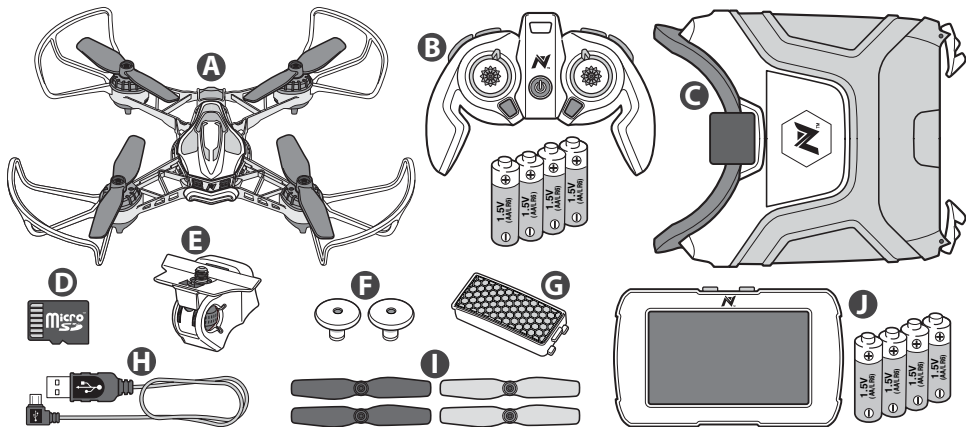

RACE VISION™ 220 FPV RACE VISION™ 220 FPV PRO

WHAT'S INCLUDED • WHAT'S INCLUDED • WHAT'S INCLUDED • WHAT'S INCLUDED •
WHAT'S INCLUDED • WHAT'S INCLUDED • WHAT'S INCLUDED • WHAT'S INCLUDED



- (GB)**
- A. Drone
 - B. Controller + 4 AA batteries
 - C. FPV goggles
(included in #22608)
 - D. SD memory card
 - E. Screen holder
 - F. Joystick
 - G. Drone battery
 - H. USB charging cable
 - I. Replaceable propellers x 4
 - J. LCD screen + 4 AA batteries

- (FR)**
- A. Drone
 - B. Controller + 4 AA batteries
 - C. FPV goggles
(included in #22608)
 - D. SD memory card
 - E. Screen holder
 - F. Joystick
 - G. Drone battery
 - H. USB charging cable
 - I. Replaceable propellers x 4
 - J. LCD screen + 4 AA batteries

- (DE)**
- A. Drone
 - B. Controller + 4 AA batteries
 - C. FPV goggles
(included in #22608)
 - D. SD memory card
 - E. Screen holder
 - F. Joystick
 - G. Drone battery
 - H. USB charging cable
 - I. Replaceable propellers x 4
 - J. LCD screen + 4 AA batteries

- (ES)**
- A. Drone
 - B. Controller + 4 AA batteries
 - C. FPV goggles
(included in #22608)
 - D. SD memory card
 - E. Screen holder
 - F. Joystick
 - G. Drone battery
 - H. USB charging cable
 - I. Replaceable propellers x 4
 - J. LCD screen + 4 AA batteries

- (IT)**
- A. Drone
 - B. Controller + 4 AA batteries
 - C. FPV goggles
(included in #22608)
 - D. SD memory card
 - E. Screen holder
 - F. Joystick
 - G. Drone battery
 - H. USB charging cable
 - I. Replaceable propellers x 4
 - J. LCD screen + 4 AA batteries

- (PT)**
- A. Drone
 - B. Controller + 4 AA batteries
 - C. FPV goggles
(included in #22608)
 - D. SD memory card
 - E. Screen holder
 - F. Joystick
 - G. Drone battery
 - H. USB charging cable
 - I. Replaceable propellers x 4
 - J. LCD screen + 4 AA batteries

- (NL)**
- A. Drone
 - B. Controller + 4 AA batteries
 - C. FPV goggles
(included in #22608)
 - D. SD memory card
 - E. Screen holder
 - F. Joystick
 - G. Drone battery
 - H. USB charging cable
 - I. Replaceable propellers x 4
 - J. LCD screen + 4 AA batteries

- (PL)**
- A. Drone
 - B. Controller + 4 AA batteries
 - C. FPV goggles
(included in #22608)
 - D. SD memory card
 - E. Screen holder
 - F. Joystick
 - G. Drone battery
 - H. USB charging cable
 - I. Replaceable propellers x 4
 - J. LCD screen + 4 AA batteries



Asst.
#22612
#22608

TOY STATE INTERNATIONAL LIMITED

66 MODY ROAD, KOWLOON, HONG KONG

www.toystate.com

www.NikkoAir.com



14+



Li-Po



**CHARGING THE DRONE • CHARGING THE DRONE • CHARGING THE DRONE •
CHARGING THE DRONE • CHARGING THE DRONE • CHARGING THE DRONE •
CHARGING THE DRONE • CHARGING THE DRONE •**

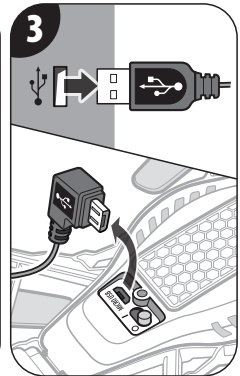
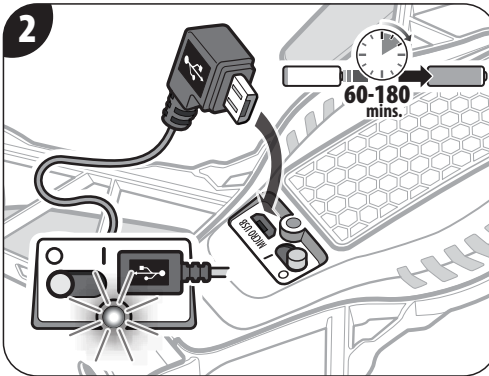
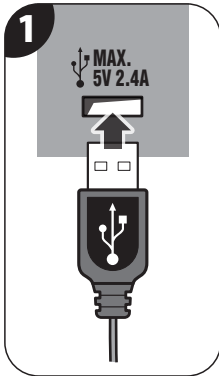

GB Caution! Make sure the drone is switched to the off position (O) before charging.

1. Plug the USB cord into computer or USB power block (Max 5V 2.4 A).
2. Insert the charging port to drone.
Red light = charging
No light = charged
3. Once charged disconnect charging cord from the drone and power source.

Charging precautions

- After use allow drone to cool down to room temperature before charging.
- After charging battery pack will feel warm, this is normal.

FR Caution! Make sure the drone is switched to the off position (O) before charging.

1. Plug the USB cord into computer or USB power block (Max 5V 2.4 A).
2. Insert the charging port to drone.
Red light = charging
No light = charged
3. Once charged disconnect charging cord from the drone and power source.

Charging precautions

- After use allow drone to cool down to room temperature before charging.
- After charging battery pack will feel warm, this is normal.

DE Caution! Make sure the drone is switched to the off position (O) before charging.

1. Plug the USB cord into computer or USB power block (Max 5V 2.4 A).
2. Insert the charging port to drone.
Red light = charging
No light = charged
3. Once charged disconnect charging cord from the drone and power source.

Charging precautions

- After use allow drone to cool down to room temperature before charging.
- After charging battery pack will feel warm, this is normal.

ES Caution! Make sure the drone is switched to the off position (O) before charging.

1. Plug the USB cord into computer or USB power block (Max 5V 2.4 A).
2. Insert the charging port to drone.
Red light = charging
No light = charged
3. Once charged disconnect charging cord from the drone and power source.

Charging precautions

- After use allow drone to cool down to room temperature before charging.
- After charging battery pack will feel warm, this is normal.

IT Caution! Make sure the drone is switched to the off position (O) before charging.

1. Plug the USB cord into computer or USB power block (Max 5V 2.4 A).
2. Insert the charging port to drone.
Red light = charging
No light = charged
3. Once charged disconnect charging cord from the drone and power source.

Charging precautions

- After use allow drone to cool down to room temperature before charging.
- After charging battery pack will feel warm, this is normal.

PT Caution! Make sure the drone is switched to the off position (O) before charging.

1. Plug the USB cord into computer or USB power block (Max 5V 2.4 A).
2. Insert the charging port to drone.
Red light = charging
No light = charged
3. Once charged disconnect charging cord from the drone and power source.

Charging precautions

- After use allow drone to cool down to room temperature before charging.
- After charging battery pack will feel warm, this is normal.

NL Caution! Make sure the drone is switched to the off position (O) before charging.

1. Plug the USB cord into computer or USB power block (Max 5V 2.4 A).
2. Insert the charging port to drone.
Red light = charging
No light = charged
3. Once charged disconnect charging cord from the drone and power source.

Charging precautions

- After use allow drone to cool down to room temperature before charging.
- After charging battery pack will feel warm, this is normal.

PL Caution! Make sure the drone is switched to the off position (O) before charging.

1. Plug the USB cord into computer or USB power block (Max 5V 2.4 A).
2. Insert the charging port to drone.
Red light = charging
No light = charged
3. Once charged disconnect charging cord from the drone and power source.

Charging precautions

- After use allow drone to cool down to room temperature before charging.
- After charging battery pack will feel warm, this is normal.





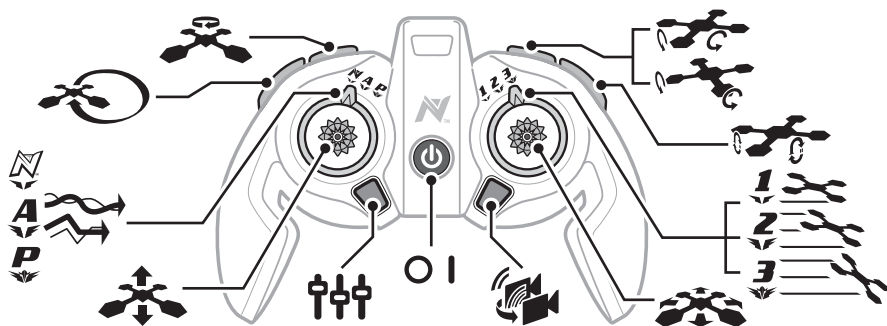

- The toy is only to be connected to Class II equipment.
- Ce jouet ne doit être raccordé qu'à un appareil de classe II.
- Das Spielzeug darf nur an Geräte der Klasse II angeschlossen werden.
- El juguete sólo debe ser conectado al equipo de Clase II.

- Il giocattolo deve essere collegato solo ad un impianto di Classe II.
- O brinquedo só deve ser ligado a equipamento de Classe II.
- Het speelgoed mag alleen worden aangesloten op klasse II apparatuur.
- Zabawkę należy podłączać wyłącznie do urządzeń Klasy II.

FLIGHT CONTROLS • FLIGHT CONTROLS • FLIGHT CONTROLS • FLIGHT CONTROLS • FLIGHT CONTROLS • FLIGHT CONTROLS • FLIGHT CONTROLS • FLIGHT CONTROLS



ONE TOUCH STUNTS • ONE TOUCH STUNTS • ONE TOUCH STUNTS • ONE TOUCH STUNTS • ONE TOUCH STUNTS • ONE TOUCH STUNTS • ONE TOUCH STUNTS • ONE TOUCH STUNTS

	FLIPS/ROLLS	EXÉCUTION DE SAUTS PÉRILLEUX/ROULEAUX	SALTOS/ROLLEN	GIROS/BUCLÉS	CAPOVOLTE/ROLLII	GIRA/ROLA	SALTO MAKEN/ROLLEN	PRZEWROTY/BE CZKI
	CROSS AXIS ROLLS	EXÉCUTION DE ROULEAUX AUTOUR D'UN AXE TRANSVERSAL	ROLLEN ÜBER DIE QUERACHSE	GIROS EN EJE CRUZADO	ROLLII INCROCIATI	ROLA SOBRE O EIXO	DWARSAS ROLLEN	BE CZKI PO PRZE KĄTNEJ
	2 STEP FLIPS/ROLLS	2 ÉTAPES EXÉCUTION DE SAUTS PÉRILLEUX /ROULEAUX	2 STUFEN SALTOS /ROLLEN	2 PASOS GIROS /BUCLÉS	2 PASSI CAPOVOLTE /ROLLII	2 PASSOS GIRA/ROLA	2 STEPS SALTO MAKEN /ROLLEN	2 KROK PRZEWROTY /BE CZKI
	360° SPINS	TOURNOIEMENTS À 360°	360° UMDREHUNGEN	GIROS EN 360°	GIRI A 360°	RODA A 360°	360° DRAAIEN	WIROWANIE 360°
	FUNNEL TURN	VIRAGES INCLINÉS À 360°	STELLE UMDREHUNG	GIROS EN EMBUDO	GIRI A IMBUTO	CURVA COM INCLINAÇÃO	TRECHTERTVORMIG DRAAIEN	PETLE POZIOME PO ELPISIE

VARIABLE FLIGHT MODES • VARIABLE FLIGHT MODES • VARIABLE FLIGHT MODES • VARIABLE FLIGHT MODES • VARIABLE FLIGHT MODES • VARIABLE FLIGHT MODES • VARIABLE FLIGHT MODES • VARIABLE FLIGHT MODES

	NIKKO MODE - GREAT FOR BEGINNERS	NIKKO MODE - GREAT FOR BEGINNERS	NIKKO MODE - GREAT FOR BEGINNERS	NIKKO MODE - GREAT FOR BEGINNERS	NIKKO MODE - GREAT FOR BEGINNERS	NIKKO MODE - GREAT FOR BEGINNERS	NIKKO MODE - GREAT FOR BEGINNERS	NIKKO MODE - GREAT FOR BEGINNERS
	ADVANCED MODE - STABILIZED	ADVANCED MODE - STABILIZED	ADVANCED MODE - STABILIZED	ADVANCED MODE - STABILIZED	ADVANCED MODE - STABILIZED	ADVANCED MODE - STABILIZED	ADVANCED MODE - STABILIZED	ADVANCED MODE - STABILIZED
	MANUAL MODE - MANUAL FLYING	MANUAL MODE - MANUAL FLYING	MANUAL MODE - MANUAL FLYING	MANUAL MODE - MANUAL FLYING	MANUAL MODE - MANUAL FLYING	MANUAL MODE - MANUAL FLYING	MANUAL MODE - MANUAL FLYING	MANUAL MODE - MANUAL FLYING

VARIABLE SPEEDS • VARIABLE SPEEDS • VARIABLE SPEEDS • VARIABLE SPEEDS • VARIABLE SPEEDS • VARIABLE SPEEDS • VARIABLE SPEEDS • VARIABLE SPEEDS



	LOW SPEED	LOW SPEED	LOW SPEED	LOW SPEED	LOW SPEED	LOW SPEED	LOW SPEED	LOW SPEED
	MID SPEED	MID SPEED	MID SPEED	MID SPEED	MID SPEED	MID SPEED	MID SPEED	MID SPEED
	HIGH SPEED	HIGH SPEED	HIGH SPEED	HIGH SPEED	HIGH SPEED	HIGH SPEED	HIGH SPEED	HIGH SPEED

THROTTLE STICK • THROTTLE STICK • THROTTLE STICK • THROTTLE STICK • THROTTLE STICK • THROTTLE STICK • THROTTLE STICK • THROTTLE STICK

	LIFTS THE DRONE OFF THE GROUND. THE FURTHER YOU PUSH THE STICK THE FASTER THE DRONE LIFTS	LIFTS THE DRONE OFF THE GROUND. THE FURTHER YOU PUSH THE STICK THE FASTER THE DRONE LIFTS	LIFTS THE DRONE OFF THE GROUND. THE FURTHER YOU PUSH THE STICK THE FASTER THE DRONE LIFTS	LIFTS THE DRONE OFF THE GROUND. THE FURTHER YOU PUSH THE STICK THE FASTER THE DRONE LIFTS	LIFTS THE DRONE OFF THE GROUND. THE FURTHER YOU PUSH THE STICK THE FASTER THE DRONE LIFTS	LIFTS THE DRONE OFF THE GROUND. THE FURTHER YOU PUSH THE STICK THE FASTER THE DRONE LIFTS	LIFTS THE DRONE OFF THE GROUND. THE FURTHER YOU PUSH THE STICK THE FASTER THE DRONE LIFTS	LIFTS THE DRONE OFF THE GROUND. THE FURTHER YOU PUSH THE STICK THE FASTER THE DRONE LIFTS
--	---	---	---	---	---	---	---	---

DIRECTIONAL STICK • DIRECTIONAL STICK • DIRECTIONAL STICK • DIRECTIONAL STICK • DIRECTIONAL STICK • DIRECTIONAL STICK • DIRECTIONAL STICK • DIRECTIONAL STICK

	THE FURTHER YOU PUSH THE STICK THE FASTER THE DRONE WILL FLY IN THAT DIRECTION	THE FURTHER YOU PUSH THE STICK THE FASTER THE DRONE WILL FLY IN THAT DIRECTION	THE FURTHER YOU PUSH THE STICK THE FASTER THE DRONE WILL FLY IN THAT DIRECTION	THE FURTHER YOU PUSH THE STICK THE FASTER THE DRONE WILL FLY IN THAT DIRECTION	THE FURTHER YOU PUSH THE STICK THE FASTER THE DRONE WILL FLY IN THAT DIRECTION	THE FURTHER YOU PUSH THE STICK THE FASTER THE DRONE WILL FLY IN THAT DIRECTION	THE FURTHER YOU PUSH THE STICK THE FASTER THE DRONE WILL FLY IN THAT DIRECTION	THE FURTHER YOU PUSH THE STICK THE FASTER THE DRONE WILL FLY IN THAT DIRECTION
--	--	--	--	--	--	--	--	--

	POWER ON/OFF	POWER ON/OFF	POWER ON/OFF	POWER ON/OFF	POWER ON/OFF	POWER ON/OFF	POWER ON/OFF	POWER ON/OFF
	TRIM ADJUSTMENT	TRIM ADJUSTMENT	TRIM ADJUSTMENT	TRIM ADJUSTMENT	TRIM ADJUSTMENT	TRIM ADJUSTMENT	TRIM ADJUSTMENT	TRIM ADJUSTMENT
	CHANNEL SELECTOR	CHANNEL SELECTOR	CHANNEL SELECTOR	CHANNEL SELECTOR	CHANNEL SELECTOR	CHANNEL SELECTOR	CHANNEL SELECTOR	CHANNEL SELECTOR

SYNCING CONTROLLER TO DRONE • SYNCING CONTROLLER TO DRONE • SYNCING CONTROLLER TO DRONE • SYNCING CONTROLLER TO DRONE • SYNCING CONTROLLER TO DRONE • SYNCING CONTROLLER TO DRONE

1

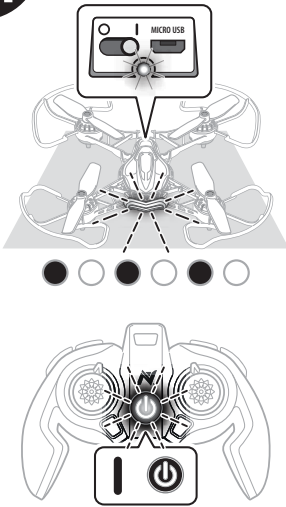

2

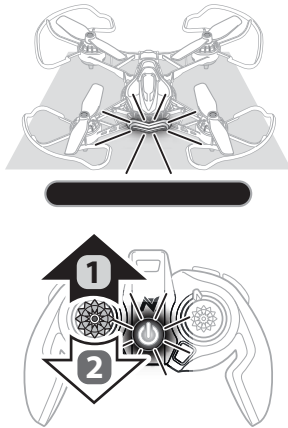

3

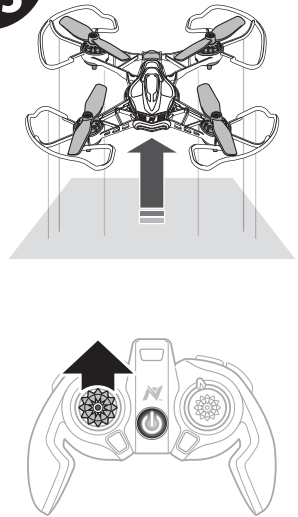

- GB** 1. Turn on remote, light will blink. Turn on the drone (I) light will blink rapidly. Place drone on a flat surface.
 2. Push throttle stick upward, then downward. The light on controller and drone will turn solid.
 3. The controller and drone are now synced. Gently push the throttle upward to lift off the ground.
- NOTE**
- If you don't fly within 5 seconds of syncing the drone or if you collide with an object the drone will disarm .
 - You need to sync the controller to the drone. Follow steps 1-3 above.

- FR** 1. Turn on remote, light will blink. Turn on the drone (I) light will blink rapidly. Place drone on a flat surface.
 2. Push throttle stick upward, then downward. The light on controller and drone will turn solid.
 3. The controller and drone are now synced. Gently push the throttle upward to lift off the ground.
- NOTE**
- If you don't fly within 5 seconds of syncing the drone or if you collide with an object the drone will disarm .
 - You need to sync the controller to the drone. Follow steps 1-3 above.

- DE** 1. Turn on remote, light will blink. Turn on the drone (I) light will blink rapidly. Place drone on a flat surface.
 2. Push throttle stick upward, then downward. The light on controller and drone will turn solid.
 3. The controller and drone are now synced. Gently push the throttle upward to lift off the ground.
- NOTE**
- If you don't fly within 5 seconds of syncing the drone or if you collide with an object the drone will disarm .
 - You need to sync the controller to the drone. Follow steps 1-3 above.

- ES** 1. Turn on remote, light will blink. Turn on the drone (I) light will blink rapidly. Place drone on a flat surface.
 2. Push throttle stick upward, then downward. The light on controller and drone will turn solid.
 3. The controller and drone are now synced. Gently push the throttle upward to lift off the ground.
- NOTE**
- If you don't fly within 5 seconds of syncing the drone or if you collide with an object the drone will disarm .
 - You need to sync the controller to the drone. Follow steps 1-3 above.

- IT** 1. Turn on remote, light will blink. Turn on the drone (I) light will blink rapidly. Place drone on a flat surface.
 2. Push throttle stick upward, then downward. The light on controller and drone will turn solid.
 3. The controller and drone are now synced. Gently push the throttle upward to lift off the ground.
- NOTE**
- If you don't fly within 5 seconds of syncing the drone or if you collide with an object the drone will disarm .
 - You need to sync the controller to the drone. Follow steps 1-3 above.

- PT** 1. Turn on remote, light will blink. Turn on the drone (I) light will blink rapidly. Place drone on a flat surface.
 2. Push throttle stick upward, then downward. The light on controller and drone will turn solid.
 3. The controller and drone are now synced. Gently push the throttle upward to lift off the ground.
- NOTE**
- If you don't fly within 5 seconds of syncing the drone or if you collide with an object the drone will disarm .
 - You need to sync the controller to the drone. Follow steps 1-3 above.

- NL** 1. Turn on remote, light will blink. Turn on the drone (I) light will blink rapidly. Place drone on a flat surface.
 2. Push throttle stick upward, then downward. The light on controller and drone will turn solid.
 3. The controller and drone are now synced. Gently push the throttle upward to lift off the ground.
- NOTE**
- If you don't fly within 5 seconds of syncing the drone or if you collide with an object the drone will disarm .
 - You need to sync the controller to the drone. Follow steps 1-3 above.

- PL** 1. Turn on remote, light will blink. Turn on the drone (I) light will blink rapidly. Place drone on a flat surface.
 2. Push throttle stick upward, then downward. The light on controller and drone will turn solid.
 3. The controller and drone are now synced. Gently push the throttle upward to lift off the ground.
- NOTE**
- If you don't fly within 5 seconds of syncing the drone or if you collide with an object the drone will disarm .
 - You need to sync the controller to the drone. Follow steps 1-3 above.

**VARIABLE FLIGHT MODES - VARIABLE FLIGHT MODES - VARIABLE FLIGHT MODES -
 VARIABLE FLIGHT MODES - VARIABLE FLIGHT MODES - VARIABLE FLIGHT MODES -
 VARIABLE FLIGHT MODES - VARIABLE FLIGHT MODES -**

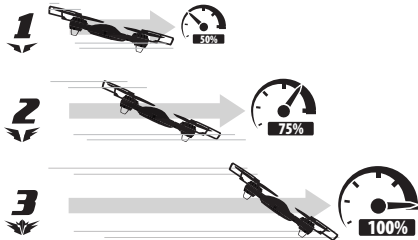
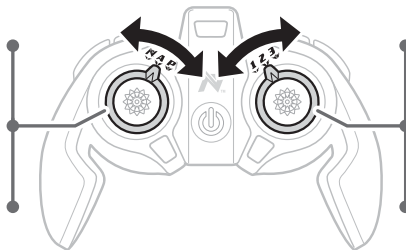

- (GB)** • Adjust the flight controls to match your skill level.
 It's best to start in Nikko Mode + Speed 1 until you have mastered flying.
- (FR)** • Adjust the flight controls to match your skill level.
 It's best to start in Nikko Mode + Speed 1 until you have mastered flying.
- (DE)** • Adjust the flight controls to match your skill level.
 It's best to start in Nikko Mode + Speed 1 until you have mastered flying.
- (ES)** • Adjust the flight controls to match your skill level.
 It's best to start in Nikko Mode + Speed 1 until you have mastered flying.

- (IT)** • Adjust the flight controls to match your skill level.
 It's best to start in Nikko Mode + Speed 1 until you have mastered flying.
- (PT)** • Adjust the flight controls to match your skill level.
 It's best to start in Nikko Mode + Speed 1 until you have mastered flying.
- (NL)** • Adjust the flight controls to match your skill level.
 It's best to start in Nikko Mode + Speed 1 until you have mastered flying.
- (PL)** • Adjust the flight controls to match your skill level.
 It's best to start in Nikko Mode + Speed 1 until you have mastered flying.

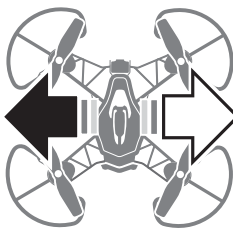
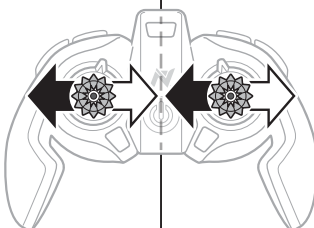
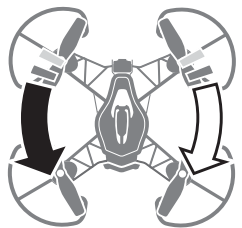
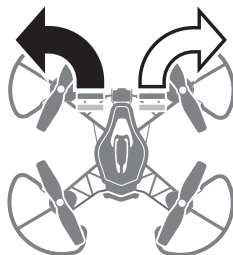
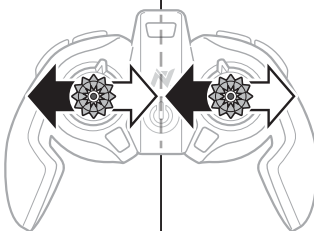
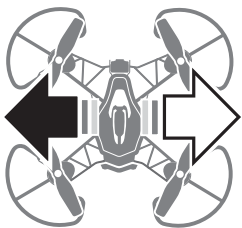
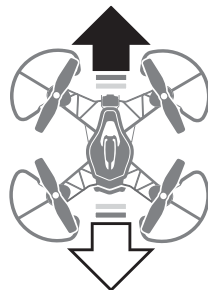
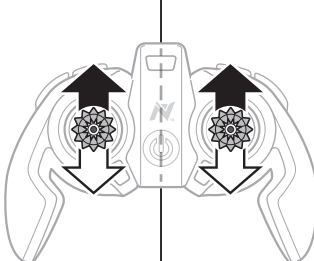
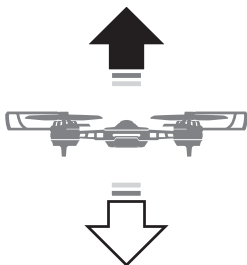

ONE TOUCH STUNTS • ONE TOUCH STUNTS • ONE TOUCH STUNTS • ONE TOUCH STUNTS • ONE TOUCH STUNTS • ONE TOUCH STUNTS • ONE TOUCH STUNTS • ONE TOUCH STUNTS •

- (GB)** Caution! Before using the stunt button, make sure to fly at least 6 feet (2m) in the air with at least 6 feet clearance in all directions.
- (FR)** Caution! Before using the stunt button, make sure to fly at least 6 feet (2m) in the air with at least 6 feet clearance in all directions.
- (DE)** Caution! Before using the stunt button, make sure to fly at least 6 feet (2m) in the air with at least 6 feet clearance in all directions.
- (ES)** Caution! Before using the stunt button, make sure to fly at least 6 feet (2m) in the air with at least 6 feet clearance in all directions.
- (IT)** Caution! Before using the stunt button, make sure to fly at least 6 feet (2m) in the air with at least 6 feet clearance in all directions.
- (PT)** Caution! Before using the stunt button, make sure to fly at least 6 feet (2m) in the air with at least 6 feet clearance in all directions.
- (NL)** Caution! Before using the stunt button, make sure to fly at least 6 feet (2m) in the air with at least 6 feet clearance in all directions.
- (PL)** Caution! Before using the stunt button, make sure to fly at least 6 feet (2m) in the air with at least 6 feet clearance in all directions.

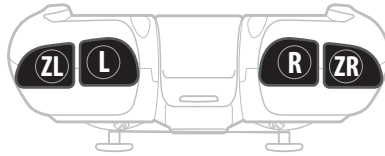

- FLIPS/ROLLS
- FLIPS/ROLLS
- FLIPS/ROLLS
- FLIPS/ROLLS
- FLIPS/ROLLS
- FLIPS/ROLLS
- FLIPS/ROLLS
- FLIPS/ROLLS

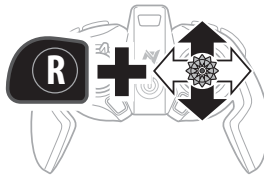

- CROSS AXIS ROLLS
- CROSS AXIS ROLLS
- CROSS AXIS ROLLS
- CROSS AXIS ROLLS
- CROSS AXIS ROLLS
- CROSS AXIS ROLLS
- CROSS AXIS ROLLS
- CROSS AXIS ROLLS

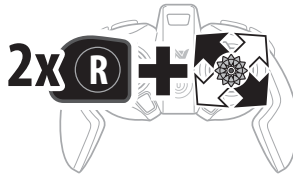

- 2 STEP FLIPS/ROLLS
- 2 STEP FLIPS/ROLLS
- 2 STEP FLIPS/ROLLS
- 2 STEP FLIPS/ROLLS
- 2 STEP FLIPS/ROLLS
- 2 STEP FLIPS/ROLLS
- 2 STEP FLIPS/ROLLS
- 2 STEP FLIPS/ROLLS

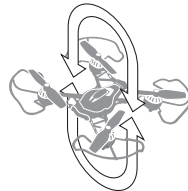
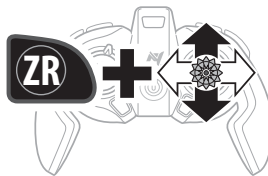

- FUNNEL TURN
- FUNNEL TURN
- FUNNEL TURN
- FUNNEL TURN
- FUNNEL TURN
- FUNNEL TURN
- FUNNEL TURN
- FUNNEL TURN

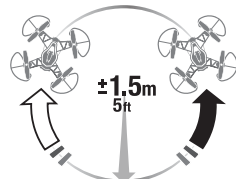
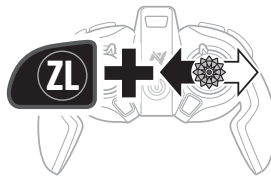

- 360° SPINS
- 360° SPINS
- 360° SPINS
- 360° SPINS
- 360° SPINS
- 360° SPINS
- 360° SPINS
- 360° SPINS

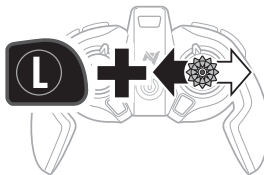

**FPV SCREEN CONTROLLER MOUNT • FPV SCREEN CONTROLLER MOUNT •
 FPV SCREEN CONTROLLER MOUNT • FPV SCREEN CONTROLLER MOUNT •
 FPV SCREEN CONTROLLER MOUNT • FPV SCREEN CONTROLLER MOUNT •
 FPV SCREEN CONTROLLER MOUNT • FPV SCREEN CONTROLLER MOUNT**

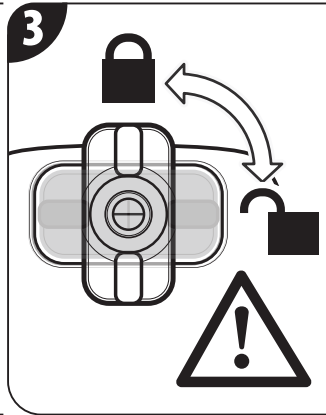
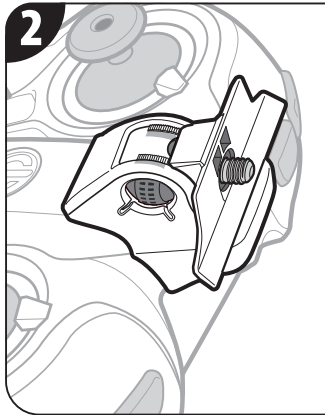
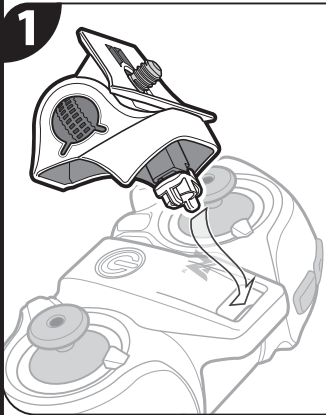

- GB** 1. Insert the locking tab on the controller mount into the slot on the controller.
 2. Press down firmly until the mount is flush to the controller.
 3. Turn the controller over. Lock the mount in position by turning the tab counterclockwise.

⚠ MAKE SURE THE LOCKING TAB IS SECURE IN THE UPRIGHT POSITION BEFORE ATTACHING THE FPV SCREEN.

- FR** 1. Insert the locking tab on the controller mount into the slot on the controller.
 2. Press down firmly until the mount is flush to the controller.
 3. Turn the controller over. Lock the mount in position by turning the tab counterclockwise.

⚠ MAKE SURE THE LOCKING TAB IS SECURE IN THE UPRIGHT POSITION BEFORE ATTACHING THE FPV SCREEN.

- DE** 1. Insert the locking tab on the controller mount into the slot on the controller.
 2. Press down firmly until the mount is flush to the controller.
 3. Turn the controller over. Lock the mount in position by turning the tab counterclockwise.

⚠ MAKE SURE THE LOCKING TAB IS SECURE IN THE UPRIGHT POSITION BEFORE ATTACHING THE FPV SCREEN.

- ES** 1. Insert the locking tab on the controller mount into the slot on the controller.
 2. Press down firmly until the mount is flush to the controller.
 3. Turn the controller over. Lock the mount in position by turning the tab counterclockwise.

⚠ MAKE SURE THE LOCKING TAB IS SECURE IN THE UPRIGHT POSITION BEFORE ATTACHING THE FPV SCREEN.

- IT** 1. Insert the locking tab on the controller mount into the slot on the controller.
 2. Press down firmly until the mount is flush to the controller.
 3. Turn the controller over. Lock the mount in position by turning the tab counterclockwise.

⚠ MAKE SURE THE LOCKING TAB IS SECURE IN THE UPRIGHT POSITION BEFORE ATTACHING THE FPV SCREEN.

- PT** 1. Insert the locking tab on the controller mount into the slot on the controller.
 2. Press down firmly until the mount is flush to the controller.
 3. Turn the controller over. Lock the mount in position by turning the tab counterclockwise.

⚠ MAKE SURE THE LOCKING TAB IS SECURE IN THE UPRIGHT POSITION BEFORE ATTACHING THE FPV SCREEN.

- NL** 1. Insert the locking tab on the controller mount into the slot on the controller.
 2. Press down firmly until the mount is flush to the controller.
 3. Turn the controller over. Lock the mount in position by turning the tab counterclockwise.

⚠ MAKE SURE THE LOCKING TAB IS SECURE IN THE UPRIGHT POSITION BEFORE ATTACHING THE FPV SCREEN.

- PL** 1. Insert the locking tab on the controller mount into the slot on the controller.
 2. Press down firmly until the mount is flush to the controller.
 3. Turn the controller over. Lock the mount in position by turning the tab counterclockwise.

⚠ MAKE SURE THE LOCKING TAB IS SECURE IN THE UPRIGHT POSITION BEFORE ATTACHING THE FPV SCREEN.

MICRO SD CARD • MICRO SD CARD • MICRO SD CARD • MICRO SD CARD •
MICRO SD CARD • MICRO SD CARD • MICRO SD CARD • MICRO SD CARD

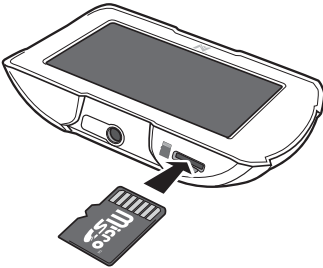

- GB** 1. Insert Micro SD card into FPV screen.
2. To remove the SD card push on the SD card slot to eject from FPV screen.
3. Use a SD card reader to retrieve the images (card reader not included).
- FR** 1. Insert Micro SD card into FPV screen.
2. To remove the SD card push on the SD card slot to eject from FPV screen.
3. Use a SD card reader to retrieve the images (card reader not included).
- DE** 1. Insert Micro SD card into FPV screen.
2. To remove the SD card push on the SD card slot to eject from FPV screen.
3. Use a SD card reader to retrieve the images (card reader not included).
- ES** 1. Insert Micro SD card into FPV screen.
2. To remove the SD card push on the SD card slot to eject from FPV screen.
3. Use a SD card reader to retrieve the images (card reader not included).
- IT** 1. Insert Micro SD card into FPV screen.
2. To remove the SD card push on the SD card slot to eject from FPV screen.
3. Use a SD card reader to retrieve the images (card reader not included).
- PT** 1. Insert Micro SD card into FPV screen.
2. To remove the SD card push on the SD card slot to eject from FPV screen.
3. Use a SD card reader to retrieve the images (card reader not included).
- NL** 1. Insert Micro SD card into FPV screen.
2. To remove the SD card push on the SD card slot to eject from FPV screen.
3. Use a SD card reader to retrieve the images (card reader not included).
- PL** 1. Insert Micro SD card into FPV screen.
2. To remove the SD card push on the SD card slot to eject from FPV screen.
3. Use a SD card reader to retrieve the images (card reader not included).

ATTACHING SCREEN TO CONTROLLER • ATTACHING SCREEN TO CONTROLLER • ATTACHING SCREEN TO CONTROLLER • ATTACHING SCREEN TO CONTROLLER •
ATTACHING SCREEN TO CONTROLLER • ATTACHING SCREEN TO CONTROLLER • ATTACHING SCREEN TO CONTROLLER • ATTACHING SCREEN TO CONTROLLER

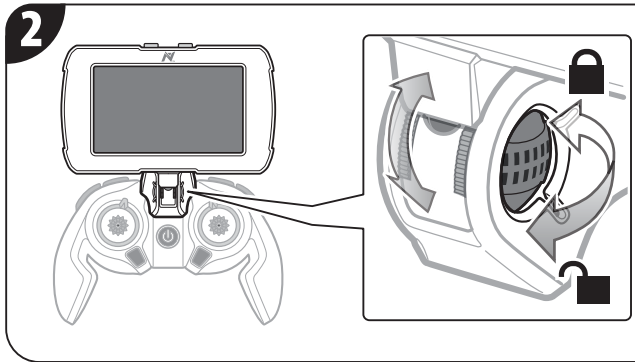
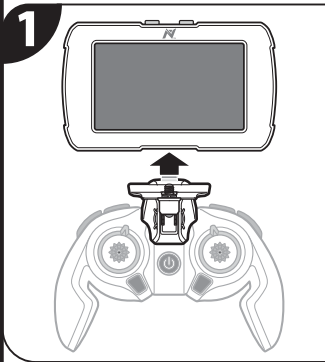

- GB** 1. Line up the hole on bottom of the LCD screen to the red screw on controller mount.
2. Place LCD screen on mount. Spin tightening ball on controller mount to secure LCD screen in place. Spin ball until screen is securely attached.
- FR** 1. Line up the hole on bottom of the LCD screen to the red screw on controller mount.
2. Place LCD screen on mount. Spin tightening ball on controller mount to secure LCD screen in place. Spin ball until screen is securely attached.
- DE** 1. Line up the hole on bottom of the LCD screen to the red screw on controller mount.
2. Place LCD screen on mount. Spin tightening ball on controller mount to secure LCD screen in place. Spin ball until screen is securely attached.
- ES** 1. Line up the hole on bottom of the LCD screen to the red screw on controller mount.
2. Place LCD screen on mount. Spin tightening ball on controller mount to secure LCD screen in place. Spin ball until screen is securely attached.
- IT** 1. Line up the hole on bottom of the LCD screen to the red screw on controller mount.
2. Place LCD screen on mount. Spin tightening ball on controller mount to secure LCD screen in place. Spin ball until screen is securely attached.
- PT** 1. Line up the hole on bottom of the LCD screen to the red screw on controller mount.
2. Place LCD screen on mount. Spin tightening ball on controller mount to secure LCD screen in place. Spin ball until screen is securely attached.
- NL** 1. Line up the hole on bottom of the LCD screen to the red screw on controller mount.
2. Place LCD screen on mount. Spin tightening ball on controller mount to secure LCD screen in place. Spin ball until screen is securely attached.
- PL** 1. Line up the hole on bottom of the LCD screen to the red screw on controller mount.
2. Place LCD screen on mount. Spin tightening ball on controller mount to secure LCD screen in place. Spin ball until screen is securely attached.

CAMERA ADJUSTMENT • CAMERA ADJUSTMENT • CAMERA ADJUSTMENT • CAMERA ADJUSTMENT •
CAMERA ADJUSTMENT • CAMERA ADJUSTMENT • CAMERA ADJUSTMENT • CAMERA ADJUSTMENT

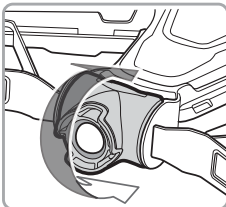

- GB** Gently rotate the angle of the camera up or downward.
- FR** Gently rotate the angle of the camera up or downward.
- DE** Gently rotate the angle of the camera up or downward.
- ES** Gently rotate the angle of the camera up or downward.
- IT** Gently rotate the angle of the camera up or downward.
- PT** Gently rotate the angle of the camera up or downward.
- NL** Gently rotate the angle of the camera up or downward.
- PL** Gently rotate the angle of the camera up or downward.

USING FPV SCREEN • USING FPV SCREEN • USING FPV SCREEN • USING FPV SCREEN • USING FPV SCREEN • USING FPV SCREEN • USING FPV SCREEN • USING FPV SCREEN

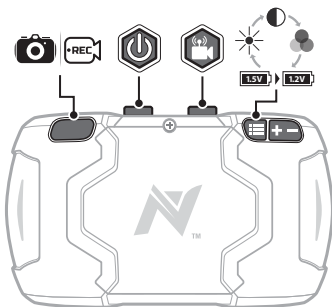

ON/OFF • ON/OFF • ON/OFF • ON/OFF • ON/OFF • ON/OFF • ON/OFF • ON/OFF • ON/OFF • ON/OFF

- GB** Push power button: to turn on or to turn off.
- FR** Push power button: to turn on or to turn off.
- DE** Push power button: to turn on or to turn off.
- ES** Push power button: to turn on or to turn off.

- IT** Push power button: to turn on or to turn off.
- PT** Push power button: to turn on or to turn off.
- NL** Push power button: to turn on or to turn off.
- PL** Push power button: to turn on or to turn off.



ADJUST DISPLAY • ADJUST DISPLAY • ADJUST DISPLAY • ADJUST DISPLAY • ADJUST DISPLAY • ADJUST DISPLAY • ADJUST DISPLAY • ADJUST DISPLAY

- GB** Adjust the brightness and contrast of the screen using the + -.
- FR** Adjust the brightness and contrast of the screen using the + -.
- DE** Adjust the brightness and contrast of the screen using the + -.
- ES** Adjust the brightness and contrast of the screen using the + -.

- IT** Adjust the brightness and contrast of the screen using the + -.
- PT** Adjust the brightness and contrast of the screen using the + -.
- NL** Adjust the brightness and contrast of the screen using the + -.
- PL** Adjust the brightness and contrast of the screen using the + -.



PICTURES & VIDEO • PICTURES & VIDEO • PICTURES & VIDEO • PICTURES & VIDEO • PICTURES & VIDEO • PICTURES & VIDEO • PICTURES & VIDEO • PICTURES & VIDEO

- GB** • Press 1 for picture.
- Press and hold for 3 seconds to record video. Press button again to end recording.
- FR** • Press 1 for picture.
- Press and hold for 3 seconds to record video. Press button again to end recording.
- DE** • Press 1 for picture.
- Press and hold for 3 seconds to record video. Press button again to end recording.
- ES** • Press 1 for picture.
- Press and hold for 3 seconds to record video. Press button again to end recording.

- IT** • Press 1 for picture.
- Press and hold for 3 seconds to record video. Press button again to end recording.
- PT** • Press 1 for picture.
- Press and hold for 3 seconds to record video. Press button again to end recording.
- NL** • Press 1 for picture.
- Press and hold for 3 seconds to record video. Press button again to end recording.
- PL** • Press 1 for picture.
- Press and hold for 3 seconds to record video. Press button again to end recording.



VIDEO CHANNEL • VIDEO CHANNEL • VIDEO CHANNEL • VIDEO CHANNEL • VIDEO CHANNEL • VIDEO CHANNEL • VIDEO CHANNEL • VIDEO CHANNEL

- GB** • There are multiple channels to allow multiple pilots to fly at once.
- Each channel has a different color that illuminates the rear light of the drone.
- Channel selection must be made before flight.
- 1. Press the "B" on the controller to select a channel.
- 2. Press the video channel button until you see image on screen and/or the color dot in the FPV screen matches the LED on the drone.
- FR** • There are multiple channels to allow multiple pilots to fly at once.
- Each channel has a different color that illuminates the rear light of the drone.
- Channel selection must be made before flight.
- 1. Press the "B" on the controller to select a channel.
- 2. Press the video channel button until you see image on screen and/or the color dot in the FPV screen matches the LED on the drone.
- DE** • There are multiple channels to allow multiple pilots to fly at once.
- Each channel has a different color that illuminates the rear light of the drone.
- Channel selection must be made before flight.
- 1. Press the "B" on the controller to select a channel.
- 2. Press the video channel button until you see image on screen and/or the color dot in the FPV screen matches the LED on the drone.
- ES** • There are multiple channels to allow multiple pilots to fly at once.
- Each channel has a different color that illuminates the rear light of the drone.
- Channel selection must be made before flight.
- 1. Press the "B" on the controller to select a channel.
- 2. Press the video channel button until you see image on screen and/or the color dot in the FPV screen matches the LED on the drone.

- IT** • There are multiple channels to allow multiple pilots to fly at once.
- Each channel has a different color that illuminates the rear light of the drone.
- Channel selection must be made before flight.
- 1. Press the "B" on the controller to select a channel.
- 2. Press the video channel button until you see image on screen and/or the color dot in the FPV screen matches the LED on the drone.
- PT** • There are multiple channels to allow multiple pilots to fly at once.
- Each channel has a different color that illuminates the rear light of the drone.
- Channel selection must be made before flight.
- 1. Press the "B" on the controller to select a channel.
- 2. Press the video channel button until you see image on screen and/or the color dot in the FPV screen matches the LED on the drone.
- NL** • There are multiple channels to allow multiple pilots to fly at once.
- Each channel has a different color that illuminates the rear light of the drone.
- Channel selection must be made before flight.
- 1. Press the "B" on the controller to select a channel.
- 2. Press the video channel button until you see image on screen and/or the color dot in the FPV screen matches the LED on the drone.
- PL** • There are multiple channels to allow multiple pilots to fly at once.
- Each channel has a different color that illuminates the rear light of the drone.
- Channel selection must be made before flight.
- 1. Press the "B" on the controller to select a channel.
- 2. Press the video channel button until you see image on screen and/or the color dot in the FPV screen matches the LED on the drone.

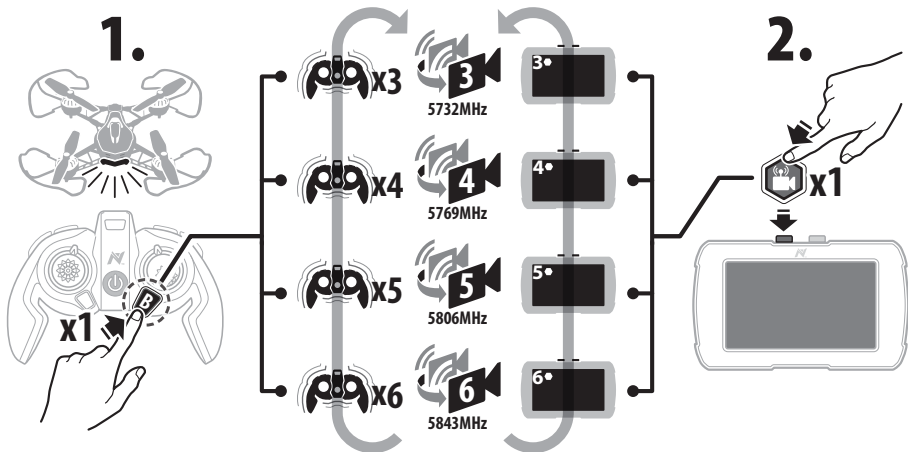

**REPLACING ROTORS • REPLACING ROTORS • REPLACING ROTORS • REPLACING ROTORS •
REPLACING ROTORS • REPLACING ROTORS • REPLACING ROTORS • REPLACING ROTORS**

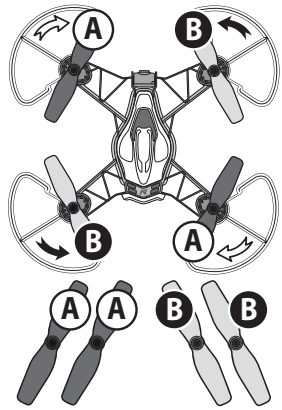
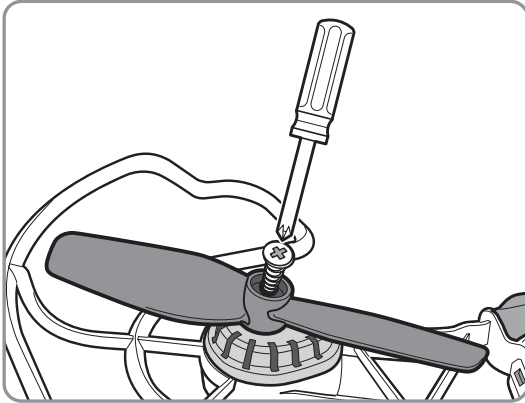

GB Make sure to use the correct replacement rotor, A or B. Markings are located on the underside of blade.

1. Remove battery from drone.
2. Remove the small screw using Phillips Head screwdriver.
3. Replace damaged rotor with a new rotor with matching letter. Secure the rotor and tighten screw.

FR Make sure to use the correct replacement rotor, A or B. Markings are located on the underside of blade.

1. Remove battery from drone.
2. Remove the small screw using Phillips Head screwdriver.
3. Replace damaged rotor with a new rotor with matching letter. Secure the rotor and tighten screw.

DE Make sure to use the correct replacement rotor, A or B. Markings are located on the underside of blade.

1. Remove battery from drone.
2. Remove the small screw using Phillips Head screwdriver.
3. Replace damaged rotor with a new rotor with matching letter. Secure the rotor and tighten screw.

ES Make sure to use the correct replacement rotor, A or B. Markings are located on the underside of blade.

1. Remove battery from drone.
2. Remove the small screw using Phillips Head screwdriver.
3. Replace damaged rotor with a new rotor with matching letter. Secure the rotor and tighten screw.

IT Make sure to use the correct replacement rotor, A or B. Markings are located on the underside of blade.

1. Remove battery from drone.
2. Remove the small screw using Phillips Head screwdriver.
3. Replace damaged rotor with a new rotor with matching letter. Secure the rotor and tighten screw.

PT Make sure to use the correct replacement rotor, A or B. Markings are located on the underside of blade.

1. Remove battery from drone.
2. Remove the small screw using Phillips Head screwdriver.
3. Replace damaged rotor with a new rotor with matching letter. Secure the rotor and tighten screw.

NL Make sure to use the correct replacement rotor, A or B. Markings are located on the underside of blade.

1. Remove battery from drone.
2. Remove the small screw using Phillips Head screwdriver.
3. Replace damaged rotor with a new rotor with matching letter. Secure the rotor and tighten screw.

PL Make sure to use the correct replacement rotor, A or B. Markings are located on the underside of blade.

1. Remove battery from drone.
2. Remove the small screw using Phillips Head screwdriver.
3. Replace damaged rotor with a new rotor with matching letter. Secure the rotor and tighten screw.

**ALTERNATIVE PRO THUMBSTICKS • ALTERNATIVE PRO THUMBSTICKS •
ALTERNATIVE PRO THUMBSTICKS • ALTERNATIVE PRO THUMBSTICKS •
ALTERNATIVE PRO THUMBSTICKS • ALTERNATIVE PRO THUMBSTICKS •
ALTERNATIVE PRO THUMBSTICKS • ALTERNATIVE PRO THUMBSTICKS**

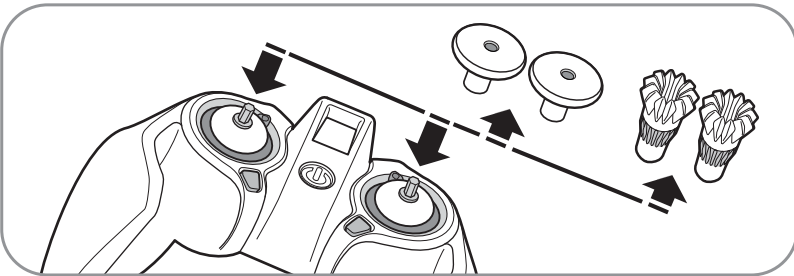

GB 1. Lift joystick upward to remove.
2. Attach thumbstick to pole to replace.

FR 1. Lift joystick upward to remove.
2. Attach thumbstick to pole to replace.

DE 1. Lift joystick upward to remove.
2. Attach thumbstick to pole to replace.

ES 1. Lift joystick upward to remove.
2. Attach thumbstick to pole to replace.

GB 1. Lift joystick upward to remove.
2. Attach thumbstick to pole to replace.

FR 1. Lift joystick upward to remove.
2. Attach thumbstick to pole to replace.

DE 1. Lift joystick upward to remove.
2. Attach thumbstick to pole to replace.

ES 1. Lift joystick upward to remove.
2. Attach thumbstick to pole to replace.

**REMOVABLE BLADE GUARDS • REMOVABLE BLADE GUARDS • REMOVABLE BLADE GUARDS •
REMOVABLE BLADE GUARDS • REMOVABLE BLADE GUARDS • REMOVABLE BLADE GUARDS •
REMOVABLE BLADE GUARDS • REMOVABLE BLADE GUARDS**

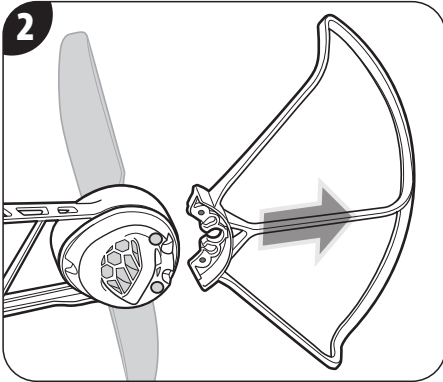
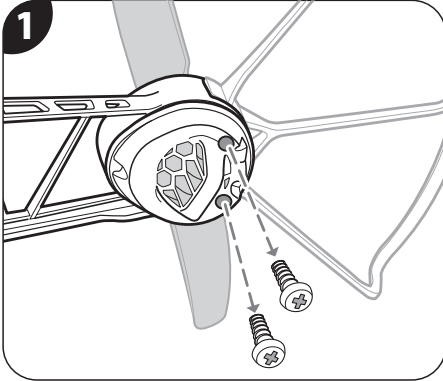

- GB** The blade guards are great for beginners and can be removed for experienced pilots.
1. Turn the drone over. Using a micro Phillips Head screwdriver, remove the 3 screws from the motor cover and set aside.
2. Remove the 2 screws inside the motor housing that hold the blade guard in place.
3. Pull the blade guard off the motor housing. Reassemble the motor cover and tighten the 3 screws back in place. Complete these steps for all blade guards.
- FR** The blade guards are great for beginners and can be removed for experienced pilots.
1. Turn the drone over. Using a micro Phillips Head screwdriver, remove the 3 screws from the motor cover and set aside.
2. Remove the 2 screws inside the motor housing that hold the blade guard in place.
3. Pull the blade guard off the motor housing. Reassemble the motor cover and tighten the 3 screws back in place. Complete these steps for all blade guards.
- DE** The blade guards are great for beginners and can be removed for experienced pilots.
1. Turn the drone over. Using a micro Phillips Head screwdriver, remove the 3 screws from the motor cover and set aside.
2. Remove the 2 screws inside the motor housing that hold the blade guard in place.
3. Pull the blade guard off the motor housing. Reassemble the motor cover and tighten the 3 screws back in place. Complete these steps for all blade guards.
- ES** The blade guards are great for beginners and can be removed for experienced pilots.
1. Turn the drone over. Using a micro Phillips Head screwdriver, remove the 3 screws from the motor cover and set aside.
2. Remove the 2 screws inside the motor housing that hold the blade guard in place.
3. Pull the blade guard off the motor housing. Reassemble the motor cover and tighten the 3 screws back in place. Complete these steps for all blade guards.
- IT** The blade guards are great for beginners and can be removed for experienced pilots.
1. Turn the drone over. Using a micro Phillips Head screwdriver, remove the 3 screws from the motor cover and set aside.
2. Remove the 2 screws inside the motor housing that hold the blade guard in place.
3. Pull the blade guard off the motor housing. Reassemble the motor cover and tighten the 3 screws back in place. Complete these steps for all blade guards.
- PT** The blade guards are great for beginners and can be removed for experienced pilots.
1. Turn the drone over. Using a micro Phillips Head screwdriver, remove the 3 screws from the motor cover and set aside.
2. Remove the 2 screws inside the motor housing that hold the blade guard in place.
3. Pull the blade guard off the motor housing. Reassemble the motor cover and tighten the 3 screws back in place. Complete these steps for all blade guards.
- NL** The blade guards are great for beginners and can be removed for experienced pilots.
1. Turn the drone over. Using a micro Phillips Head screwdriver, remove the 3 screws from the motor cover and set aside.
2. Remove the 2 screws inside the motor housing that hold the blade guard in place.
3. Pull the blade guard off the motor housing. Reassemble the motor cover and tighten the 3 screws back in place. Complete these steps for all blade guards.
- PL** The blade guards are great for beginners and can be removed for experienced pilots.
1. Turn the drone over. Using a micro Phillips Head screwdriver, remove the 3 screws from the motor cover and set aside.
2. Remove the 2 screws inside the motor housing that hold the blade guard in place.
3. Pull the blade guard off the motor housing. Reassemble the motor cover and tighten the 3 screws back in place. Complete these steps for all blade guards.

**ADJUSTING THE TRIM • ADJUSTING THE TRIM • ADJUSTING THE TRIM •
ADJUSTING THE TRIM • ADJUSTING THE TRIM • ADJUSTING THE TRIM •
ADJUSTING THE TRIM • ADJUSTING THE TRIM**

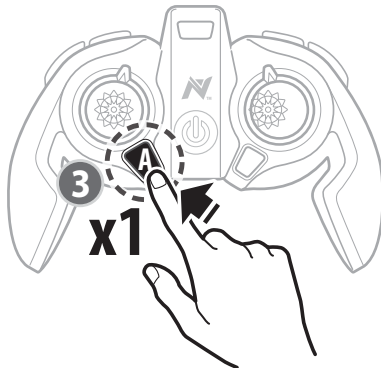
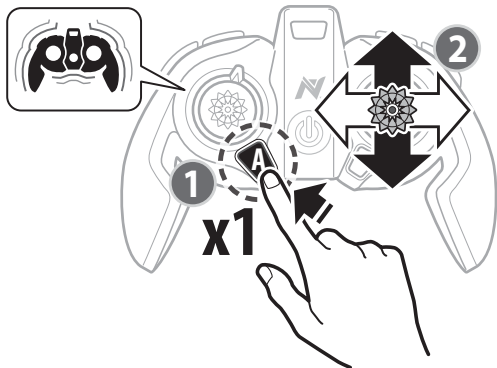

GB You may notice a "pull" in one direction when flying, this is known as drift. You may need to adjust the trim to ensure best performance and eliminate drift.

1. With the drone on the ground and the throttle stick (left stick) set to lowest position, press A to enter trim mode.
2. Quickly push the right stick in the opposite direction from the drift direction and let it set back to the center.
3. Push A again to exit trim mode.

Do a test flight. If the drone still drifts, repeat steps 1 to 3.

NOTE

Adjust trim when the drone is landed not while flying.

FR You may notice a "pull" in one direction when flying, this is known as drift. You may need to adjust the trim to ensure best performance and eliminate drift.

1. With the drone on the ground and the throttle stick (left stick) set to lowest position, press A to enter trim mode.
2. Quickly push the right stick in the opposite direction from the drift direction and let it set back to the center.
3. Push A again to exit trim mode.

Do a test flight. If the drone still drifts, repeat steps 1 to 3.

NOTE

Adjust trim when the drone is landed not while flying.

DE You may notice a "pull" in one direction when flying, this is known as drift. You may need to adjust the trim to ensure best performance and eliminate drift.

1. With the drone on the ground and the throttle stick (left stick) set to lowest position, press A to enter trim mode.
2. Quickly push the right stick in the opposite direction from the drift direction and let it set back to the center.
3. Push A again to exit trim mode.

Do a test flight. If the drone still drifts, repeat steps 1 to 3.

NOTE

Adjust trim when the drone is landed not while flying.

ES You may notice a "pull" in one direction when flying, this is known as drift. You may need to adjust the trim to ensure best performance and eliminate drift.

1. With the drone on the ground and the throttle stick (left stick) set to lowest position, press A to enter trim mode.
2. Quickly push the right stick in the opposite direction from the drift direction and let it set back to the center.
3. Push A again to exit trim mode.

Do a test flight. If the drone still drifts, repeat steps 1 to 3.

NOTE

Adjust trim when the drone is landed not while flying.

IT You may notice a "pull" in one direction when flying, this is known as drift. You may need to adjust the trim to ensure best performance and eliminate drift.

1. With the drone on the ground and the throttle stick (left stick) set to lowest position, press A to enter trim mode.
2. Quickly push the right stick in the opposite direction from the drift direction and let it set back to the center.
3. Push A again to exit trim mode.

Do a test flight. If the drone still drifts, repeat steps 1 to 3.

NOTE

Adjust trim when the drone is landed not while flying.

PT You may notice a "pull" in one direction when flying, this is known as drift. You may need to adjust the trim to ensure best performance and eliminate drift.

1. With the drone on the ground and the throttle stick (left stick) set to lowest position, press A to enter trim mode.
2. Quickly push the right stick in the opposite direction from the drift direction and let it set back to the center.
3. Push A again to exit trim mode.

Do a test flight. If the drone still drifts, repeat steps 1 to 3.

NOTE

Adjust trim when the drone is landed not while flying.

NL You may notice a "pull" in one direction when flying, this is known as drift. You may need to adjust the trim to ensure best performance and eliminate drift.

1. With the drone on the ground and the throttle stick (left stick) set to lowest position, press A to enter trim mode.
2. Quickly push the right stick in the opposite direction from the drift direction and let it set back to the center.
3. Push A again to exit trim mode.

Do a test flight. If the drone still drifts, repeat steps 1 to 3.

NOTE

Adjust trim when the drone is landed not while flying.

PL You may notice a "pull" in one direction when flying, this is known as drift. You may need to adjust the trim to ensure best performance and eliminate drift.

1. With the drone on the ground and the throttle stick (left stick) set to lowest position, press A to enter trim mode.
2. Quickly push the right stick in the opposite direction from the drift direction and let it set back to the center.
3. Push A again to exit trim mode.

Do a test flight. If the drone still drifts, repeat steps 1 to 3.

NOTE

Adjust trim when the drone is landed not while flying.

- GB** The DRL racing simulator allows new pilots to learn how to fly a racing drone.
- Practice the controls and perfect the basics before taking flight in real life.
 - Master your skills and race against your friends.
 - Compete in actual DRL courses.
- Learn more and download the simulator at:
www.NikkoAir.com
- FR** The DRL racing simulator allows new pilots to learn how to fly a racing drone.
- Practice the controls and perfect the basics before taking flight in real life.
 - Master your skills and race against your friends.
 - Compete in actual DRL courses.
- Learn more and download the simulator at:
www.NikkoAir.com
- DE** The DRL racing simulator allows new pilots to learn how to fly a racing drone.
- Practice the controls and perfect the basics before taking flight in real life.
 - Master your skills and race against your friends.
 - Compete in actual DRL courses.
- Learn more and download the simulator at:
www.NikkoAir.com
- ES** The DRL racing simulator allows new pilots to learn how to fly a racing drone.
- Practice the controls and perfect the basics before taking flight in real life.
 - Master your skills and race against your friends.
 - Compete in actual DRL courses.
- Learn more and download the simulator at:
www.NikkoAir.com
- IT** The DRL racing simulator allows new pilots to learn how to fly a racing drone.
- Practice the controls and perfect the basics before taking flight in real life.
 - Master your skills and race against your friends.
 - Compete in actual DRL courses.
- Learn more and download the simulator at:
www.NikkoAir.com
- PT** The DRL racing simulator allows new pilots to learn how to fly a racing drone.
- Practice the controls and perfect the basics before taking flight in real life.
 - Master your skills and race against your friends.
 - Compete in actual DRL courses.
- Learn more and download the simulator at:
www.NikkoAir.com
- NL** The DRL racing simulator allows new pilots to learn how to fly a racing drone.
- Practice the controls and perfect the basics before taking flight in real life.
 - Master your skills and race against your friends.
 - Compete in actual DRL courses.
- Learn more and download the simulator at:
www.NikkoAir.com
- PL** The DRL racing simulator allows new pilots to learn how to fly a racing drone.
- Practice the controls and perfect the basics before taking flight in real life.
 - Master your skills and race against your friends.
 - Compete in actual DRL courses.
- Learn more and download the simulator at:
www.NikkoAir.com

- GB SYNC CONTROLLER TO SIMULATOR :**
1. Using the USB charging cord, plug the USB into the computer and insert the charging port to the drone.
 2. Turn on the power of the drone and the controller.
 3. Arm the drone. Push "B" for 5 seconds until the rear lights of the drone turn green and fade on and off.
 4. Follow the instructions in the simulator to finish setup.
 5. To switch back to flying mode push "B" for 5 seconds until the rear lights of drone are blinking.
- FR SYNC CONTROLLER TO SIMULATOR :**
1. Using the USB charging cord, plug the USB into the computer and insert the charging port to the drone.
 2. Turn on the power of the drone and the controller.
 3. Arm the drone. Push "B" for 5 seconds until the rear lights of the drone turn green and fade on and off.
 4. Follow the instructions in the simulator to finish setup.
 5. To switch back to flying mode push "B" for 5 seconds until the rear lights of drone are blinking.

DE SYNC CONTROLLER TO SIMULATOR :

1. Using the USB charging cord, plug the USB into the computer and insert the charging port to the drone.
2. Turn on the power of the drone and the controller.
3. Arm the drone. Push "B" for 5 seconds until the rear lights of the drone turn green and fade on and off.
4. Follow the instructions in the simulator to finish setup.
5. To switch back to flying mode push "B" for 5 seconds until the rear lights of drone are blinking.

ES SYNC CONTROLLER TO SIMULATOR :

1. Using the USB charging cord, plug the USB into the computer and insert the charging port to the drone.
2. Turn on the power of the drone and the controller.
3. Arm the drone. Push "B" for 5 seconds until the rear lights of the drone turn green and fade on and off.
4. Follow the instructions in the simulator to finish setup.
5. To switch back to flying mode push "B" for 5 seconds until the rear lights of drone are blinking.

IT SYNC CONTROLLER TO SIMULATOR :

1. Using the USB charging cord, plug the USB into the computer and insert the charging port to the drone.
2. Turn on the power of the drone and the controller.
3. Arm the drone. Push "B" for 5 seconds until the rear lights of the drone turn green and fade on and off.
4. Follow the instructions in the simulator to finish setup.
5. To switch back to flying mode push "B" for 5 seconds until the rear lights of drone are blinking.

PT SYNC CONTROLLER TO SIMULATOR :

1. Using the USB charging cord, plug the USB into the computer and insert the charging port to the drone.
2. Turn on the power of the drone and the controller.
3. Arm the drone. Push "B" for 5 seconds until the rear lights of the drone turn green and fade on and off.
4. Follow the instructions in the simulator to finish setup.
5. To switch back to flying mode push "B" for 5 seconds until the rear lights of drone are blinking.

NL SYNC CONTROLLER TO SIMULATOR :

1. Using the USB charging cord, plug the USB into the computer and insert the charging port to the drone.
2. Turn on the power of the drone and the controller.
3. Arm the drone. Push "B" for 5 seconds until the rear lights of the drone turn green and fade on and off.
4. Follow the instructions in the simulator to finish setup.
5. To switch back to flying mode push "B" for 5 seconds until the rear lights of drone are blinking.

PL SYNC CONTROLLER TO SIMULATOR :

1. Using the USB charging cord, plug the USB into the computer and insert the charging port to the drone.
2. Turn on the power of the drone and the controller.
3. Arm the drone. Push "B" for 5 seconds until the rear lights of the drone turn green and fade on and off.
4. Follow the instructions in the simulator to finish setup.
5. To switch back to flying mode push "B" for 5 seconds until the rear lights of drone are blinking.

BETA FLIGHT • BETA FLIGHT • BETA FLIGHT • BETA FLIGHT • BETA FLIGHT • BETA FLIGHT • BETA FLIGHT

- GB** Beta Flight software allows you to customize your controls. Learn more at: www.NikkoAir.com
- FR** Beta Flight software allows you to customize your controls. Learn more at: www.NikkoAir.com
- DE** Beta Flight software allows you to customize your controls. Learn more at: www.NikkoAir.com
- ES** Beta Flight software allows you to customize your controls. Learn more at: www.NikkoAir.com

- IT** Beta Flight software allows you to customize your controls. Learn more at: www.NikkoAir.com
- PT** Beta Flight software allows you to customize your controls. Learn more at: www.NikkoAir.com
- NL** Beta Flight software allows you to customize your controls. Learn more at: www.NikkoAir.com
- PL** Beta Flight software allows you to customize your controls. Learn more at: www.NikkoAir.com

BATTERY & REPLACEMENT PARTS • BATTERY & REPLACEMENT PARTS • BATTERY & REPLACEMENT PARTS • BATTERY & REPLACEMENT PARTS • BATTERY & REPLACEMENT PARTS • BATTERY & REPLACEMENT PARTS • BATTERY & REPLACEMENT PARTS

- GB** For replacement parts and accessories please visit: www.NikkoAir.com
- FR** For replacement parts and accessories please visit: www.NikkoAir.com
- DE** For replacement parts and accessories please visit: www.NikkoAir.com
- ES** For replacement parts and accessories please visit: www.NikkoAir.com

- IT** For replacement parts and accessories please visit: www.NikkoAir.com
- PT** For replacement parts and accessories please visit: www.NikkoAir.com
- NL** For replacement parts and accessories please visit: www.NikkoAir.com
- PL** For replacement parts and accessories please visit: www.NikkoAir.com

TROUBLE SHOOTING • TROUBLE SHOOTING • TROUBLE SHOOTING • TROUBLE SHOOTING • TROUBLE SHOOTING • TROUBLE SHOOTING • TROUBLE SHOOTING

PROBLEM	SOLUTION
The drone is unresponsive	<ul style="list-style-type: none"> • Make sure the battery is fully charged and power is on. • Drone may be disarmed. Follow the syncing instructions to ensure the controller is paired with drone.
The FPV screen only shows static	<ul style="list-style-type: none"> • Make sure the drone and screen are on the same video channel.
Blades spin but drone doesn't fly properly	<ul style="list-style-type: none"> • Drone blades may have been installed incorrectly. Make sure the correct blade "A" or "B" was installed in the correct position.

PROBLEM	SOLUTION
The drone is unresponsive	<ul style="list-style-type: none"> • Make sure the battery is fully charged and power is on. • Drone may be disarmed. Follow the syncing instructions to ensure the controller is paired with drone.
The FPV screen only shows static	<ul style="list-style-type: none"> • Make sure the drone and screen are on the same video channel.
Blades spin but drone doesn't fly properly	<ul style="list-style-type: none"> • Drone blades may have been installed incorrectly. Make sure the correct blade "A" or "B" was installed in the correct position.

PROBLEM	SOLUTION
The drone is unresponsive	<ul style="list-style-type: none"> • Make sure the battery is fully charged and power is on. • Drone may be disarmed. Follow the syncing instructions to ensure the controller is paired with drone.
The FPV screen only shows static	<ul style="list-style-type: none"> • Make sure the drone and screen are on the same video channel.
Blades spin but drone doesn't fly properly	<ul style="list-style-type: none"> • Drone blades may have been installed incorrectly. Make sure the correct blade "A" or "B" was installed in the correct position.

PROBLEM	SOLUTION
The drone is unresponsive	<ul style="list-style-type: none"> • Make sure the battery is fully charged and power is on. • Drone may be disarmed. Follow the syncing instructions to ensure the controller is paired with drone.
The FPV screen only shows static	<ul style="list-style-type: none"> • Make sure the drone and screen are on the same video channel.
Blades spin but drone doesn't fly properly	<ul style="list-style-type: none"> • Drone blades may have been installed incorrectly. Make sure the correct blade "A" or "B" was installed in the correct position.

PROBLEM	SOLUTION
The drone is unresponsive	<ul style="list-style-type: none"> • Make sure the battery is fully charged and power is on. • Drone may be disarmed. Follow the syncing instructions to ensure the controller is paired with drone.
The FPV screen only shows static	<ul style="list-style-type: none"> • Make sure the drone and screen are on the same video channel.
Blades spin but drone doesn't fly properly	<ul style="list-style-type: none"> • Drone blades may have been installed incorrectly. Make sure the correct blade "A" or "B" was installed in the correct position.

PROBLEM	SOLUTION
The drone is unresponsive	<ul style="list-style-type: none"> • Make sure the battery is fully charged and power is on. • Drone may be disarmed. Follow the syncing instructions to ensure the controller is paired with drone.
The FPV screen only shows static	<ul style="list-style-type: none"> • Make sure the drone and screen are on the same video channel.
Blades spin but drone doesn't fly properly	<ul style="list-style-type: none"> • Drone blades may have been installed incorrectly. Make sure the correct blade "A" or "B" was installed in the correct position.

PROBLEM	SOLUTION
The drone is unresponsive	<ul style="list-style-type: none"> • Make sure the battery is fully charged and power is on. • Drone may be disarmed. Follow the syncing instructions to ensure the controller is paired with drone.
The FPV screen only shows static	<ul style="list-style-type: none"> • Make sure the drone and screen are on the same video channel.
Blades spin but drone doesn't fly properly	<ul style="list-style-type: none"> • Drone blades may have been installed incorrectly. Make sure the correct blade "A" or "B" was installed in the correct position.

SAFETY PRECAUTION

EN



14+ OUTDOOR TOYS INTENDED FOR CHILDREN OVER 14 YEARS OF AGE.



DO NOT TOUCH THE RUNNING ROTORS.

HANDS, HAIR AND LOOSE CLOTHES SHALL BE KEPT AWAY FROM THE ROTORS.

IMPORTANT! Carefully read the Owners Manual before play! Keep the Manual for later reference.

CAUTION:

- DO NOT START UP AND FLY WHEN PERSONS, ANIMALS OR ANY OBSTRUCTIONS ARE WITHIN THE FLYING RANGE OF THE DRONE (FLYING RANGE: 50m).
- RISK OF EYE INJURIES: DO NOT FLY NEAR YOUR FACE TO AVOID INJURIES.
- UNDER THE ENVIRONMENT WITH ELECTROSTATIC DISCHARGE, THE PRODUCT MAY MALFUNCTION AND REQUIRE USER TO RESET THE PRODUCT.

ATTENTION!

Never fly without direct sight contact to your drone, you have to keep eye contact at all times. Controlling a drone through virtual reality glasses is prohibited, if you are flying it alone and outside. You can control the drone with your glasses outside, if somebody else watches out. There are no restrictions for the use of drones in closed rooms.

• If you oppose above security warning you can get in conflict with local law.



- Only operate the drone and its accessories when fully assembled and in accordance with this manual!
- Keep the instructions manual for later reference.
- Before first use. Read the instruction manual together with your child.
- Operations and safe use must be explained (preferably by graphical illustrations).
- Flying the drone requires skill and children must be trained under the direct supervision of adult.
- Check if the drone is assembled as instructed. Assembly shall be performed under the supervision of adult.
- This drone is intended to be used only outdoors—NOT to be indoors. RISK OF EYE INJURIES
- Start and fly only when the area is appropriate for the intended use (free area, no obstacles) and only within direct visual contact.
- Start and fly is strictly forbidden near high voltage poles railway tracks, roads, swimming pools or open water.
- Only operate under good visibility and clam weather conditions.
- Intended for children age 14 and older.
- Never fly in a place cluttered with obstacles.
- Operate the drone in a safe area away from people, pets, cars, etc.
- Do not touch or try to pick up the drone when it is in motion. Wait until it has stopped completely.
- Keep hair, fingers, face and loose clothing away from the running rotors while the drone is switched on or while the controller is operating.
- Do not drop or give impact to the drone and its accessories.
- Do not change or modify anything on the drone.
- Never attempt to disassemble or modify the drone or its accessories.
- Remove rechargeable batteries from the product before charging.



NOTE: BATTERIES MUST BE RECYCLED OR DISPOSED PROPERLY.

Contact your local area office of solid waste management or other appropriate local agency for information.

- Make sure the batteries are inserted with correct polarity.
- Use only battery type(s) recommended.
- Do not attempt to short-circuit, charge, disassemble or heat batteries.
- Do not dispose of batteries in fire or make them wet.
- Do not mix or use new and old or different types of batteries together.
- Non-rechargeable batteries are not to be recharged.
- Rechargeable batteries are only to be charged by adult.
- Battery replacement should be done in presence of an adult.
- Remove batteries from the product for storage.
- After use, be sure to turn the switch off. Failure to do so may adversely affect batteries, resulting in disabled charged.
- Exhausted batteries are to be removed from the toy.
- Regularly examine for damage to the plug, enclosure and other parts, in the event of any damage, the toy must not be used with the transmitter charger until the damage has been repaired.
- For best performance, always use alkaline batteries only. To remove the batteries, reverse the installation procedure.

MANUFACTURER'S NOTE

- Modifications not authorized by the manufacturer may void users authority to operate the device.
- This drone and all accessories need to be periodically examined for potential hazards and any potentially hazardous parts be repaired or replaced.
- In the interest of better quality and value, we are constantly improving and updating our products.
- Consequently, pictures in this instruction sheet may sometimes differ from the model enclosed.
- You are advised to retain the packaging for future reference as it contains important information.

FEDERAL COMMUNICATIONS COMMISSION COMPLIANCE

NOTE: This device complies with Part 15 of the FCC Rules. Operation is subject to the following two conditions:

(1) this device may not cause harmful interference, and

(2) this device must accept any interference received, including interference that may cause undesired operation.

Warning: Changes or modifications to this unit not expressly approved by the party responsible for compliance could void the user's authority to operate the equipment. NOTE: This equipment has been tested and found to comply with the limits for a Class B digital device, pursuant to Part 15 of the FCC Rules. These limits are designed to provide reasonable protection against harmful interference in a residential installation. This equipment generates, uses and can radiate radio frequency energy and, if not installed and used in accordance with the instructions, may cause harmful interference to radio communications. However, there is no guarantee that interference will not occur in a particular installation. If this equipment does cause harmful interference to radio or television reception, which can be determined by turning the equipment off and on, the user is encouraged to try to correct the interference by one or more of the following measures:

- Reorient or relocate the receiving antenna.
- Increase the separation between the equipment and receiver.
- Connect the equipment into an outlet on a circuit different from that to which the receiver is connected.
- Consult the dealer or an experienced radio/TV technician for help.



14+ JOUETS PLEIN AIR DESTINÉS AUX ENFANTS DE PLUS DE 14 ANS.



NE PAS TOUCHER LE ROTORS EN ROTATION.

MAINTENIR MAINS, CHEVEUX ET VÊTEMENTS AMPLES À L'ÉCART DU ROTORS.

IMPORTANT! Lisez attentivement le manuel d'utilisation avant de jouer ! Conservez le manuel afin de pouvoir vous y référer ultérieurement.

ATTENTION:

- NE PAS DÉMARRER ET FAIRE VOLER LE DRONE LORSQUE DES PERSONNES, ANIMAUX OU D'ÉVENTUELLES OBSTRUCTIONS SE TROUVENT DANS LE RAYON D'ACTION DE CELUI-CI (RAYON D'ACTION: 50m).
- RISQUE DE BLESSURES AUX YEUX: ÉVITE DE FAIRE VOLER L'HÉLICOPTÈRE PRÈS DU VISAGE AFIN DE PRÉVENIR TOUTES BLESSURES.
- DANS UN ENVIRONNEMENT COMPORTANT DES DÉCHARGES ÉLECTROSTATIQUES, LE PRODUIT PRÉSENTE DES RISQUES DE DYSFONCTIONNEMENT, NÉCESSITANT UNE RÉINITIALISATION DU PRODUIT PAR L'UTILISATEUR.

ATTENTION !

Ne jamais faire voler ton drone sans contact visuel direct avec celui-ci ; tu dois garder un contact visuel en tout temps. Le contrôle d'un drone à travers des lunettes de réalité virtuelle est interdit, si tu le fais seul et à l'extérieur. Tu peux contrôler le drone avec tes lunettes à l'extérieur, si quelqu'un d'autre le surveille. Il n'existe aucune restriction quant à l'utilisation de drones dans des pièces fermées.

- Si tu t'opposes à l'avertissement de sécurité ci-dessus, tu risques d'entrer en conflit avec la législation locale.



- Utilise le drone et ses accessoires seulement après montage complet conformément aux instructions contenues dans le présent manuel !
- Veuillez bien conserver ces instructions afin de pouvoir t'y référer ultérieurement.
- Avant la première utilisation, veuillez lire le manuel d'instructions avec votre enfant.
- Il convient d'expliquer son fonctionnement et utilisation en toute sécurité (de préférence à l'aide d'illustrations graphiques).
- Le pilotage de l'hélicoptère drone nécessite des compétences et les enfants doivent recevoir une formation sous l'étroite surveillance d'un adulte.
- Vérifiez si le drone est monté conformément aux instructions. Le montage doit être effectué sous la surveillance d'un adulte.

Cet hélicoptère drone est conçu pour être utilisé en extérieur exclusivement – NE PAS utiliser à l'intérieur! RISQUE DE BLESSURES AUX YEUX

Démarré et fais voler l'appareil uniquement lorsque la zone est adaptée à l'utilisation prévue (zones libres et sans obstacles) et ce exclusivement en contact visuel direct.

Démarrage et vol strictement interdits à proximité de pylônes haute tension, de voies ferrées, de routes, de piscines ou en eau ouverte.

Pilote uniquement lorsque la visibilité est bonne et les conditions atmosphériques calmes.

Prévu pour enfants de 14 ans et plus.

Ne volez jamais à un endroit plein d'obstacles.

Fais voler le drone dans une zone sécurisée à l'écart des personnes, animaux de compagnie, voitures, etc.

Évite de toucher ou d'essayer d'attraper le drone lorsque celui-ci est en mouvement. Patientez jusqu'à son arrêt complet.

Maintenir les cheveux, les doigts, le visage et les vêtements amples à l'écart du rotor en rotation après le démarrage du drone ou pendant que le dispositif de commande est en cours de fonctionnement.

Éviter au drone et à ses accessoires toutes chutes et tous chocs violents.

Ne changer, ni ne modifier aucun élément de l'hélicoptère drone.

Ne tente jamais de démonter ou de modifier l'hélicoptère drone ou ses accessoires.

Retire les piles rechargeables du produit avant de les charger.



REMARQUE: LES PILES DOIVENT ÊTRE RECYCLÉES OU MISES AU REBUT CORRECTEMENT.

Pour toutes informations, contactez le centre de gestion des déchets solides de votre localité ou tout autre organisme local approprié.

Assure-toi que les piles sont insérées avec la polarité correcte.

Utilise exclusivement des piles du type recommandé.

Ne tente pas de court-circuiter, charger, démonter ou incinérer les piles.

N'incinère jamais tes piles et ne les trempe pas dans l'eau.

Ne mélange, ni n'utilise jamais des piles neuves et usagées ou de types différents.

Ne recharge pas des piles non rechargeables.

Les piles rechargeables doivent être rechargées uniquement sous la surveillance d'un adulte.

Le remplacement des piles doit être effectué en présence d'un adulte.

Retire les piles du produit avant de le ranger.

Après emploi, coupe l'interrupteur. Le non-respect de cette consigne risque d'affecter négativement les piles et entraîner leur déchargement.

Les piles usagées doivent être retirées du jouet.

Examinez régulièrement la fiche, l'enceinte et d'autres parties par rapport aux dommages éventuels. En cas de dommage visible, le jouet ne doit pas être utilisé avec le chargeur de l'émetteur jusqu'à ce que le dommage a été réparé.

Pour obtenir des performances optimales, toujours utiliser exclusivement des piles alcalines. Pour retirer les piles, inverse la procédure d'installation.

CERTIFICATION FCC

REMARQUE : Cet appareil est conforme à la Section 15 du règlement de la FCC. Son utilisation est soumise aux deux conditions suivantes :

(1) cet appareil ne peut pas causer de brouillage préjudiciable, et

(2) cet appareil doit accepter toutes les interférences reçues, y compris celles susceptibles d'engendrer un dysfonctionnement.

Avertissement : Tout apport de changement ou de modification à cette unité qui n'est pas approuvé expressément par la partie responsable de la conformité peut annuler le droit de l'utilisateur d'utiliser l'appareil. REMARQUE : Cet appareil a été testé et respecte les limites prévues pour un appareil numérique de classe B, conformément à la section 15 du règlement FCC. Ces limites sont conçues pour assurer une protection raisonnable contre les interférences nuisibles dans des bâtiments à vocation résidentielle. Cet appareil génère, utilise et peut émettre de l'énergie radioélectrique, et s'il n'est pas installé et utilisé conformément aux instructions, il peut causer des interférences préjudiciables pour les communications radio. Cependant, nous ne pouvons garantir qu'aucun brouillage ne se produira dans une installation particulière. Si cet appareil produit des interférences préjudiciables lors de réception radio ou télévisée qui peuvent être détectées en allumant et en éteignant l'appareil, l'utilisateur est prié de les supprimer d'une ou de plusieurs manières :

- Réorienter ou déplacer l'antenne de réception.

- Augmenter la distance entre l'appareil et le récepteur.

- Brancher l'appareil à une prise de courant d'un circuit différent de celui auquel le récepteur est branché.

- Consulter le revendeur ou un technicien radio/TV expérimenté pour obtenir de l'aide.

- Toute modification non autorisée par le fabricant peut annuler le droit qu'a l'utilisateur d'utiliser l'appareil.
- Ce jouet ainsi que tous les accessoires doivent être périodiquement vérifiés afin de détecter tout danger et toute pièce potentiellement dangereuse doit être réparée ou remplacée.
- Soucieux d'offrir une qualité et une valeur sans cesse supérieures, nous améliorons et mettons à jour nos produits constamment.
- En conséquence, les images de ce manuel peuvent parfois différer du modèle ci-joint.
- Nous recommandons de garder toutes les informations relatives à ce produit pour référence future.

SICHERHEITSVORKEHRUNGEN

DE



14+ SPIELZEUG FÜR DRAUSSEN NUR FÜR KINDER ÜBER 14 JAHREN GEEIGNET



DEN LAUFENDEN ROTOR NICHT BERÜHREN.

HÄNDE, HAARE UND LOCKERE KLEIDUNG VOM ROTOR FERNHALTEN.

WICHTIG! Lesen Sie die Gebrauchsanweisung vor dem Spielen! Diese Gebrauchsanweisung zum späteren Nachschlagen gut aufbewahren.

VORSICHT:

- DEN BETRIEB NICHT STARTEN, FALLS INNERHALB DES FLUGBEREICHS DES DROHNES PERSONEN, TIERE ODER HINDERNISSE VORHANDEN SIND (RAYON D'ACTION: 50m).
- RISIKO VON AUGENVERLETZUNGEN: NICHT ZU NAH AM GESICHT FLIEGEN LASSEN, UM VERLETZUNGEN ZU VERMEIDEN.
- ELEKTROSTATISCHE ENTLADUNG KANN FEHLFUNKTIONEN VERURSACHEN; IN SOLCH EINEM FALL MUSS DAS PRODUKT ZURÜCKGESETZT WERDEN.

ACHTUNG!

Fliegen Sie niemals ohne direktem Sichtkontakt zu Ihrer Drohne, bewahren Sie sie zu jeder Zeit im Auge. Die Steuerung einer Drohne über eine Virtual-Reality-Brille ist verboten, wenn Sie diese alleine und im Freien fliegen. Sie können die Drohne im Freien nur dann mit Ihrer Brille steuern, wenn sie von jemand anders überwacht wird. Es gibt keine Einschränkungen für die Verwendung von Drohnen in geschlossenen Räumen.

- Wenn Sie gegen Sicherheitswarnungen verstoßen, können Sie in Konflikt mit den örtlichen Gesetzen gelangen.



- Der Quadcopter und dessen Zubehör dürfen nur nach der vollständigen Montage und gemäß dieser Bedienungsanleitung betrieben werden!
- Bewahren Sie die Bedienungsanleitung für ein späteres Nachschlagen gut auf.
- Lesen Sie die Bedienungsanleitung vor dem erstmaligen Gebrauch gemeinsam mit Ihrem Kind durch.
- Funktionen und der sichere Gebrauch müssen erläutert werden (vorzugsweise anhand graphischer Abbildungen).
- Für das Fliegen des Drohnes sind Kenntnisse erforderlich; Kinder müssen unter direkter Aufsicht durch einen Erwachsenen angeleitet werden.
- Überprüfen Sie, ob der Drohne gemäß den Anleitungen installiert wurde. Die Installation muss unter Aufsicht durch einen Erwachsenen durchgeführt werden.
- Dieser Drohne ist nur für den Gebrauch im Freien bestimmt –NICHT in Innenräumen verwenden. RISIKO VON AUGENVERLETZUNGEN:
- Starten Sie den Flugbetrieb nur, wenn der Flugbereich für den bestimmungsgemäßen Gebrauch geeignet ist (frei, ohne Hindernisse) und innerhalb Ihres direkten Sichtfeldes liegt.
- Sie dürfen das Produkt nicht in der Nähe von Hochspannungsmasten, Gleisen, Straßen, Schwimmbecken oder offenen Gewässern verwenden.
- Verwenden Sie das Gerät nur bei guter Sicht und unter ruhigen Wetterbedingungen.
- Für Kinder ab 14 Jahren.
- Fliegen Sie niemals an einem Ort voller Hindernissen.
- Verwenden Sie den Drohne an einem sicheren Ort, fern von Personen, Tieren, Autos, usw.
- Versuchen Sie nicht, den Drohne zu berühren oder anzuheben, wenn dieser in Bewegung ist. Warten Sie, bis er vollständig zum Stillstand gekommen ist.
- Halten Sie Haare, Finger, Gesicht und lockere Kleidung vom laufenden Rotor fern, während der Drohne eingeschaltet oder die Steuerung in Betrieb ist.
- Den Drohne und dessen Zubehör vor Aufprall schützen und nicht fallenlassen.
- Nehmen Sie an dem Drohne keine Änderungen oder Modifikationen vor.
- Versuchen Sie niemals, den Quadcopter oder dessen Zubehör auseinanderzubauen oder zu modifizieren.
- Retire les piles rechargeables du produit avant de les charger.



HINWEIS: BATTERIEN MÜSSEN ORDNUNGSGEMÄSS RECYCLT BZW. ENTSORGT WERDEN.

Nähere Informationen erhalten Sie auf Ihrer örtlichen Gemeinde, Ihrer Abfallbehörde oder einer anderen zuständigen Behörde vor Ort.

- Vergewissern Sie sich, dass die Batterien der Polarität entsprechend eingelegt sind.
- Verwenden Sie nur empfohlene Batterietypen.
- Batterien dürfen nicht kurzgeschlossen, aufgeladen, demontiert oder erhitzt werden.
- Batterien nicht ins Feuer werfen oder nass werden lassen.
- Niemals alte und neue Batterien oder Batterien unterschiedlicher Typen gemeinsam verwenden.
- Nicht wiederaufladbare Batterien dürfen nicht aufgeladen werden.
- Wiederaufladbare Batterien dürfen nur von einem Erwachsenen aufgeladen werden.
- Batterien dürfen nur in Anwesenheit eines Erwachsenen ausgetauscht werden.
- Entnehmen Sie die Batterien vor der Lagerung des Produkts.
- Schalten Sie das Gerät nach dem Gebrauch aus. Anderenfalls könnten die Batterien beeinträchtigt und als Folge entladen werden.
- Entnehmen Sie verbrauchte Batterien aus dem Gerät.
- Prüfen Sie das Spielzeug regelmäßig auf Schäden an Kabel, Stecker, Gehäuse und anderen Teilen. Im Falle eines sichtbaren Schadens, darf das Spielzeug erst wieder mit diesem Ladegerät verwendet werden, wenn der Schaden behoben worden ist.
- Verwenden Sie im Hinblick auf einen optimalen Betrieb nur Alkalibatterien. Entnehmen Sie Batterien in umgekehrter Reihenfolge der Installation.

- Änderungen, die nicht ausdrücklich vom hersteller genehmigt wurden, können die Betriebserlaubnis des benutzers erlöschen lassen.
- Dieses spielzeug und alle zubehörteile müssen regelmäßig auf potenzielle gefahren untersucht zu werden, und möglicherweise gefährliche teile müssen repariert oder ersetzt werden.
- Im interesse einer besseren qualität und leistung, verbessern und aktualisieren wir ständig unsere produkte.
- Folglich können abbildungen in dieser bedienungsanleitung manchmal vom mitgelieferten modell abweichen.
- Wir empfehlen ihnen, alle produktinformationen für einen späteren zeitpunkt aufzubewahren.

MEDIDA DE SEGURIDAD

ES



14+ LOS JUGUETES PARA EXTERIORES ESTÁN DESTINADOS A NIÑOS MAYORES DE 14 AÑOS DE EDAD.



NO TOQUE LOS ROTORES EN MOVIMIENTO.

LAS MANOS, EL CABELLO Y LA ROPA SUELTA DEBEN MANTENERSE ALEJADOS DE LOS ROTORES.

¡IMPORTANTE! ¡Lea atentamente el manual del propietario antes de jugar! Guarde el manual para su posterior consulta.

PRECAUCIÓN:

- NO ENCIENDA EL DRONE NI LO HAGA VOLAR CUANDO PERSONAS, ANIMALES U OTRAS OBSTRUCCIONES SE ENCUENTREN DENTRO DEL RANGO DE VUELO (RANGO DE VUELO: 50m).
- RIESGO DE LESIONES OCULARES: PARA EVITAR LESIONES, NO VUELVE EL DISPOSITIVO CERCA DE SU ROSTRO.
- EN ENTORNOS CON DESCARGAS ELECTROESTÁTICAS, EL PRODUCTO PODRÍA NO FUNCIONAR CORRECTAMENTE, POR LO QUE EL USUARIO DEBERÁ RESTABLECERLO.

¡ATENCIÓN!

Jamás vuele sin tener un contacto visual directo con su drone; debe mantener el contacto visual en todo momento. Se prohíbe controlar un drone mediante gafas de realidad virtual si lo está volando solo y en exteriores. Puede controlar al drone con sus gafas en exteriores, si alguien más está mirando. No hay restricciones para el uso de drones en habitaciones cerradas.

- Si no sigue la advertencia de seguridad anterior, podría tener conflictos legales con su autoridad local.



- ¡Utilice únicamente el drone y sus accesorios cuando lo haya montado por completo según este manual!
- Conserve el manual de instrucciones como futura referencia.
- Antes del primer uso. Lea el manual de instrucciones junto con su hijo.
- El funcionamiento y la seguridad deben explicarse (preferiblemente con ilustraciones gráficas).
- Para volar el drone se requiere habilidad y los niños deben ser entrenados directamente bajo la supervisión de un adulto.
- Compruebe si el drone está montado tal y como se indica. El montaje debe llevarse a cabo bajo la supervisión de un adulto.

- Este cuadricóptero está hecho solo para uso en exteriores, NO en interiores. RIESGO DE LESIONES OCULARES
- Encienda y vuele solo en una área apta para el uso previsto (una zona despejada sin obstáculos) y solo dentro de contacto visual directo.
- Está estrictamente prohibido encender y volar este dispositivo cerca de ferrovías, postes de alta tensión, caminos, piscinas o aguas abiertas.
- Utilice sólo bajo condiciones de buena visibilidad y clima calmado.
- Concebido para niños a partir de los 14 años.
- Nunca vuele en un lugar atestado de obstáculos.
- Utilice el cuadricóptero en una área segura, lejos de la gente, mascotas, coches, etc.
- No toque o intente recoger el drone cuando se encuentre en marcha. Espere hasta que se haya detenido por completo.
- Mantenga el pelo, los dedos, la cara y la ropa suelta lejos del rotor en marcha mientras el drone está encendido o mientras el controlador está funcionando.
- No lance o impacte el drone y sus accesorios.
- No cambie o modifique el drone.
- Nunca intente desmontar o modificar el drone o sus accesorios.
- Retire las baterías recargables del producto antes de recargarlas.



NOTA: LAS BATERÍAS DEBEN SER RECICLADAS O DESECHADAS DE MANERA ADECUADA.

Póngase en contacto con su oficina local de gestión de residuos sólidos u otra agencia local apropiada y pida información.

- Asegúrese de que las baterías están colocadas con la polaridad correcta.
- Utilice únicamente los tipos de baterías recomendados.
- No origine un cortocircuito, carga, desmontaje o calentamiento de las baterías.
- No deseche las baterías en el fuego o las moje.
- No mezcle o utilice nuevas y viejas o diferentes tipos de baterías conjuntamente.
- Las baterías no recargables no pueden ser recargadas.
- Las baterías recargables solamente pueden ser cargadas por un adulto.
- La sustitución de las baterías solamente puede realizarse con la presencia de un adulto.
- Para almacenar el producto, retire las baterías.
- Después de su uso, asegúrese de apagarlo. De lo contrario, ello puede afectar a las baterías ocasionando una carga defectuosa.
- Las baterías agotadas tienen que ser extraídas del juguete.
- Examine regularmente en caso de que haya daños en el enchufe, la carcasa u otras partes. En caso de cualquier daño, el juguete no debe ser utilizado con el cargador del transmisor hasta que el daño haya sido reparado.
- Para obtener un mejor rendimiento, utilice siempre sólo pilas alcalinas. Para extraer las baterías, invierta el procedimiento de instalación.

NOTA DEL FABRICANTE

- Las Modificaciones No Autorizadas Por El Fabricante Pueden Anular La Autoridad Del Usuario Para Operar El Dispositivo.
- Este Juguete Y Todos Sus Accesorios Deben Examinarse Periódicamente Para Identificar Posibles Peligros Y Piezas Peligrosas Que Deban Repararse O Cambiarse.
- Para Obtener El Máximo Valor Y La Máxima Calidad, Constantemente Mejoramos Y Actualizamos Nuestros Productos.
- Consecuentemente, Las Imágenes De Esta Hoja De Instrucciones Podrían, A Veces, Diferir Del Modelo Adquirido.
- Guarde toda la información relacionada con este producto para posibles usos en el futuro.

NOTA: Este dispositivo cumple con la Parte 15 de las Regulaciones FCC. La operación queda sujeta a las siguientes dos condiciones:

- (1) este dispositivo no puede provocar interferencias peligrosas, y
 - (2) este dispositivo debe aceptar cualquier interferencia recibida, incluyendo aquellas que puedan provocar un funcionamiento no deseado.
- Advertencia: Los cambios o modificaciones a este producto sin la aprobación expresa de la parte responsable del dicho cumplimiento podrían anular la autoridad del usuario para operar el equipo. NOTA: Este equipo se ha probado y comprobado en relación a su cumplimiento con los límites para los dispositivos digitales Clase B, según la Parte 15 de las Regulaciones FCC. Estos límites están diseñados para proporcionar una protección razonable contra interferencias dañinas en una instalación residencial. Este equipo genera, utiliza y puede emitir energía de radiofrecuencias, la cual, de no instalarse según las instrucciones, puede provocar interferencia dañina a las comunicaciones por radio. No obstante, no hay garantía de que no ocurra interferencia en una instalación en particular. Si este equipo no provoca interferencia dañina a la recepción de radio o televisión, lo cual puede determinarse encendiendo o apagando el equipo, se anima al usuario a intentar corregir la interferencia mediante uno o más de los siguientes pasos:
- Reorientar o reubique la antena receptora.
 - Aumente la separación entre el equipo y el receptor.
 - Conecte el equipo en un tomacorriente en un circuito diferente al que está conectado el receptor.
 - Consulte con su vendedor minorista o con un técnico especializado en radio/TV para obtener ayuda.

CONSIGLI PER LA SICUREZZA

IT



14+ I GIOCATTOLE PER USO ALL'APERTO SONO ADATTI A BAMBINI DAI 14 ANNI IN SU.



NON TOCCARE IL ROTORE SE IN FUNZIONE. TENERE MANI, CAPELLI E ABITI LARGHI LONTANO DAL ROTORE.

IMPORTANTE! Leggere con attenzione il Manuale Utente prima di giocare! Conservare il Manuale per consultazioni future.

ATTENZIONE:

- NON AVVIARE O FAR VOLARE QUANDO PERSONE, ANIMALI O ALTRE OSTRUZIONI SONO NEL CAMPO DI VOLO DEL drone (RANGE DI VOLO: 50m).
- RISCHIO DI FERITE AGLI OCCHI: NON FAR VOLARE VICINO AL VISO PER EVITARE INFORTUNI
- UNDER THE ENVIRONMENT WITH ELECTROSTATIC DISCHARGE, THE PRODUCT MAY MALFUNCTION AND REQUIRE USER TO RESET THE PRODUCT.

ATTENZIONE!

Non far volare mai il drone senza avere un contatto visivo diretto con esso. È necessario mantenere il contatto visivo in ogni singolo momento. È vietato manovrare un drone attraverso visori per realtà virtuale quando si è da soli e in ambienti esterni. È possibile manovrare il drone in ambienti esterni attraverso il visore solo sotto la supervisione di una terza persona. Non esistono restrizioni all'utilizzo di droni in ambienti chiusi.

- Il mancato rispetto di questi avvisi di sicurezza può costituire una violazione delle normative locali.
- Utilizzare il drone ed i suoi accessori esclusivamente quando completamente assemblato e in conformità con questo manuale!
- Conservare il manuale d'istruzioni per riferimento futuro.
- Prima del primo utilizzo. Leggere il manuale di istruzioni insieme al vostro bambino.
- L'utilizzo e la sicurezza devono essere spiegati (preferibilmente con illustrazioni grafiche).
- Far volare il drone richiede abilità, i bambini devono essere addestrati sotto la diretta supervisione di un adulto.
- Assicurarsi che il drone sia assemblato secondo le istruzioni. L'assemblaggio deve essere effettuato sotto la supervisione di un adulto.

- Questo drone è destinato ad essere utilizzato solo all'aperto - NON all'interno. RISCHIO DI FERITE AGLI OCCHI.
- Avviare e far volare solo quando l'area è appropriata per l'utilizzo (area libera, senza ostacoli) e solo se si ha continuo contatto visivo diretto.
- È severamente vietato l'utilizzo vicino a cavi e pali ad alta tensione, binari ferroviari, strade, piscine o in mare.
- Utilizzare solo in condizioni di buona visibilità e condizioni meteorologiche tranquille.
- Adatto a bambini da 14 anni in su.
- Non far volare mai in posti con molti ostacoli.
- Utilizzare il drone in una zona sicura lontano da persone, animali, automobili, ecc.

- Non toccare o cercare di afferrare il drone quando è in movimento. Attendere fino a quando si è fermato completamente.
- Tenere capelli, dita, viso e gli abiti larghi lontani dal rotore in movimento, quando il drone è acceso o quando il telecomando è in funzione.
- Non far cadere o far subire impatti al drone ed i suoi accessori.
- Non cambiare nulla né modificare il drone.
- Non tentare di smontare o modificare il drone o dei suoi accessori.
- Non toccare o cercare di afferrare il drone quando è in movimento. Attendere fino a quando si è fermato completamente.



NOTA: LE BATTERIE DEVONO ESSERE RICICLATE O SMALTITE IN MODO CORRETTO.

Contattare le autorità locali per la gestione dei rifiuti solidi o altra agenzia appropriata per informazioni a riguardo.

- Assicurarsi che le batterie siano inserite con la corretta polarità.
- Utilizzare solo il tipo di batteria(e) consigliato.
- Non tentare di mettere le batterie in corto circuito, caricarle, smontarle o esporle a fonti di calore.
- Non gettare le batterie nel fuoco e non bagnarle.
- Non utilizzare simultaneamente batterie vecchie e nuove o diversi tipi di batterie.
- Le batterie non ricaricabili non devono essere ricaricate.
- Le batterie ricaricabili devono essere ricaricate solo da adulti.
- La sostituzione della batteria deve essere effettuata in presenza di un adulto.
- Rimuovere le batterie dal prodotto prima dello stoccaggio.
- Dopo l'uso, assicurarsi di spegnere l'interruttore. Si rischia altrimenti di danneggiare le batterie e la loro capacità di carica.
- Le batterie esaurite devono essere rimosse dal giocattolo.
- Esaminare regolarmente la presenza di danni alla spina, all'involucro e alle altre parti, nel caso di eventuali danni, il giocattolo non deve essere usato con il trasmettitore fino a quando i danni non vengono riparati.
- Per prestazioni ottimali, usare sempre e solo batterie alcaline. Per rimuovere le batterie, invertire la procedura di installazione.

- Modifiche non autorizzate dal produttore potrebbero invalidare il diritto dell'utente a utilizzare il dispositivo.
- Il giocattolo e tutti gli accessori devono essere regolarmente esaminati per verificare l'esistenza di potenziali rischi. Ogni parte che costituisce un potenziale rischio deve essere riparata o sostituita.
- Per garantire standard di qualità e valore sempre elevati, miglioriamo e aggiorniamo costantemente i nostri prodotti.
- Pertanto, le figure nella presente scheda di istruzioni potrebbero differire dal modello contenuto nella confezione.
- Si consiglia di conservare tutte le informazioni legate a questo prodotto per riferimenti futuri.

PRECAUÇÕES DE SEGURANÇA

PT



14+ BRINQUEDOS DE EXTERIOR DESTINADOS A CRIANÇAS COM MAIS DE 14 ANOS DE IDADE.



NÃO TOCAR NOS ROTORES EM FUNCIONAMENTO.

AS MÃOS, OS CABELOS E AS ROUPAS LARGAS DEVEM SER MANTIDOS AFASTADOS DO ROTOR.

IMPORTANTE! Leia cuidadosamente o manual do fabricante antes de brincar! Guarde o manual para referência futura.

CUIDADO:

- NÃO INICIE O VOO QUANDO HOUVER PESSOAS, ANIMAIS OU QUAISQUER OBSTRUÇÕES DENTRO DA ÁREA DE VOO DO DUADRICOPTERO (ÁREA DE VOO: 50m).
- RISCO DE LESÕES OCULARES: NÃO FAZER VOAR PERTO DO ROSTO PARA EVITAR FERIMENTOS.
- NUM AMBIENTE COM DESCARGAS ELETROESTÁTICAS, O PRODUTO PODE FUNCIONAR MAL E SER NECESSÁRIO QUE O UTILIZADOR REINICIALIZA O PRODUTO.

ATENÇÃO!

Nunca voar sem ter contacto visual direto com o seu drone, tem sempre que manter o contacto visual. Controlar um drone através de óculos de realidade virtual é proibido, se estiver a voar sozinho e no exterior. Pode controlar o drone com os seus óculos no exterior, se mais alguém estiver a vigiar. Não existem restrições para o uso de drones em espaços fechados.

- Caso ultrapasse e ignore o aviso de segurança, poderá entrar em conflito com a legislação local.

- Apenas fazer funcionar o quadricóptero e os seus acessórios quando já estiverem totalmente montados de acordo com este manual!
- Guarde o manual de instruções para referência futura.
- Antes da primeira utilização: Leia o manual de instruções juntamente com a criança.
- O funcionamento e a utilização segura devem ser explicados (de preferência através de ilustrações gráficas).
- Fazer voar o quadricóptero requer perícia e as crianças têm de se ser treinadas com a supervisão direta de um adulto responsável.
- Verifique se o quadricóptero está montado de acordo com as instruções. A montagem deve ser efetuado com a supervisão de um adulto responsável.

- Este quadricóptero destina-se a ser utilizado apenas ao ar livre - e NÃO dentro de casa. RISCO DE LESÕES OCULARE.
- Iniciar o voo apenas quando a área é adequada para o uso a que se destina (área livre, sem obstáculos) e somente a manter contacto visual direto.
- Iniciar o voo é estritamente proibido perto de postes alta tensão, caminhos de ferro, estradas, piscinas ou mar/águas abertas.
- Operar apenas em condições de boa visibilidade e boas condições climáticas.
- Destina-se a crianças com mais de 14 anos de idade.
- Nunca voar num local cheio de obstáculos.
- Operar o quadricóptero numa área segura e afastado de pessoas, animais, carros, etc.
- Não tocar nem tentar pegar no quadricóptero quando está em movimento. Aguardar até ficar completamente parado.
- Mantenha o cabelo, os dedos, o rosto e as roupas largas afastados do rotor em movimento enquanto o quadricóptero é ligado ou quando o controlador está a funcionar.
- Não deixar cair nem causar impactos no quadricóptero e respetivos acessórios.
- Não alterar nem modificar nada no quadricóptero.
- Nunca tentar desmontar ou modificar o quadricóptero ou os seus acessórios.
- Entnehmen Sie die Akkus vor dem Aufladen aus dem Spielzeug.



NOTA: AS PILHAS E BATERIAS DEVEM SER RECICLADAS OU ELIMINADAS DE FORMA CORRETA.

Contacte a administração local que trata da gestão de resíduos sólidos ou outra agência apropriada para obter informações.

- Certifique-se de que as pilhas são inseridas com a polaridade correta.
- Use apenas os tipos de pilhas recomendados.
- Não tente causar curto-circuito, carregar, desmontar ou aquecer as pilhas.
- Não deite as pilhas no lume nem as molhe.
- Não misture pilhas velhas e novas nem use diferentes tipos de pilhas.
- As pilhas não recarregáveis não podem ser recarregadas.
- As pilhas recarregáveis só devem ser recarregadas por adultos.
- A substituição das pilhas só deve ser feita com a supervisão de um adulto.
- Remova as pilhas do produto antes de o guardar.
- Depois de utilizar, certifique-se de que desligou o interruptor. Se não o desligar, pode afectar as pilhas e descarregá-las.
- As pilhas gastas devem ser retiradas do brinquedo.
- Verifique regularmente a existência de danos na ficha, invólucro e outras peças. Em caso de danos, o brinquedo não deve ser usado com o carregador transmissor até que o dano tenha sido reparado.
- Para um melhor desempenho, use sempre e só pilhas alcalinas. Para remover as pilhas, inverta o processo da instalação.

NOTA DO FABRICAN

- Modificações não autorizadas por parte do fabricante poderão anular a autoridade do utilizador em operar o dispositivo.
- Este brinquedo e todos os acessórios necessitam de ser examinados periodicamente quanto a potenciais perigos e quaisquer peças em potencial perigo devem ser reparadas ou substituídas.
- No interesse da melhor qualidade e valor, estamos constantemente a melhorar e a atualizar os nossos produtos.
- Assim, as imagens desta folha de instruções poderá, por vezes, diferir do modelo anexo.
- O informamos que guarde toda a informação relativa a este produto para futura referência.



14+ BUITEN SPEELGOED BEDOELD VOOR KINDEREN BOVEN 14 JAAR OUD.



RAAK DE BEWEGENDE ROTOREN NIET AAN.

HOUD HANDEN, HAAR EN LOSSE KLEDING UIT DE BUURT VAN DE ROTOR.

BELANGRIJK! Lees zorgvuldig de gebruikshandleiding voor het spelen! Bewaar de handleiding om in de toekomst te raadplegen.

OPGELET:

- NIET INSCHAKELEN ALS ER ZICH PERSONEN, DIEREN OF OBSTAKELS BINNEN HET VliegBEREIK VAN DE drone BEVINDEN. (VliegBEREIK: 50m).
- Vlieg NIET IN DE BUURT VAN UW GEZICHT OM LETSEL TE VOORKOMEN.
- ELEKTROSTATISCHE ONTLADING KAN EEN VERKEERDE WERKING VAN HET PRODUCT VEROORZAKEN WAARDOOR DE GEBRUIKER HET PRODUCT DIENT TE RESETTEN.

OPGELET!

Houd uw drone op elk moment in het oog. Uw drone besturen via een virtual reality-bril is niet toegestaan wanneer u het alleen en buitenshuis laat vliegen. U kunt de drone met uw bril buitenshuis besturen wanneer iemand anders de drone in het oog houdt. Er is geen beperkingen voor wat betreft het gebruik van drones in afgesloten ruimten.

- Als bovenstaande veiligheidswaarschuwing niet wordt nageleefd, is het mogelijk dat u de lokale wetgeving overtreedt.



- Gebruik de drone en toebehoren alleen wanneer het volledig en in overeenstemming met deze gebruiksaanwijzing in elkaar is gezet.
- Bewaar de gebruiksaanwijzing voor latere raadpleging.
- Voor ingebruikname Lees de gebruiksaanwijzing samen met uw kind.
- Leg de gebruiks- en veiligheidsinstructies duidelijk uit (bij voorkeur met behulp van de grafische afbeeldingen).
- Het vliegen van de drone vergt enige vaardigheid en kinderen moeten onder het direct toezicht van een volwassene worden opgeleid.
- Controleer of de drone in elkaar is gezet zoals beschreven. De montage dient te gebeuren onder het toezicht van een volwassene.
- Dit drone is alleen bedoeld voor gebruik buitenshuis – NIET binnenshuis. RISICO OP OOGLETSEL.
- Start en vlieg alleen wanneer het gebied voor het bedoeld gebruik geschikt is (onbelemmerd en zonder obstakels) en alleen binnen rechtstreeks visueel contact.
- Het is verboden om de drone te starten en te laten vliegen in de buurt van hoogspanningsmasten, treinsporen, wegen, zwembaden of open water.
- Alleen te gebruiken bij een goede zichtbaarheid en rustige weersomstandigheden.
- Bestemd voor kinderen vanaf 14 jaar oud.
- Vlieg nooit in een plaats dat is volgestopt met obstakels.
- Bestuur de drone in een veilig gebied, uit de buurt van mensen, huisdieren, auto's, etc.
- Raak de drone niet aan of neem het niet op wanneer het in beweging is. Wacht totdat het tot een volledige stilstand is gekomen.
- Houd haar, vingers, het gezicht en losse kleding uit de buurt van de draaiende rotor wanneer de drone is ingeschakeld of wanneer de zender in werking is.
- Laat de drone of het toebehoren niet vallen of stoot nergens tegen.
- Wijzig of pas niets aan de drone aan.
- Demonteer of pas de drone of het toebehoren nooit aan. Haal oplaadbare batterijen uit het speelgoed voordat u ze oplaadt.



OPMERKING: RECYCLE OF GOOI BATTERIJEN OP EEN JUISTE MANIER WEG.

Neem contact op met uw gemeente of lokaal inzamelpunt voor meer informatie.

- Plaats de batterijen volgens de juiste polariteit.
- Gebruik alleen batterijen van het aanbevolen type.
- Probeer niet om de batterijen kort te sluiten, te laden, uit elkaar te halen of op te warmen.
- Gooi geen batterijen in het vuur of maak ze niet nat.
- Meng geen oude met nieuwe batterijen of batterijen van een verschillend type.
- Wegwerpbatterijen mogen niet opgeladen worden.
- Oplaadbare batterijen mogen alleen door een volwassene worden opgeladen.
- Vervang de batterijen onder het toezicht van een volwassene.
- Haal de batterijen uit het product voordat u het opbergt.
- Schakel het product uit na gebruik. De batterijen kunnen worden beschadigd, zodat het opladen ervan niet langer mogelijk is.
- Verwijder gebruikte batterijen uit het speelgoed.
- Controleer regelmatig op schade aan de plug, behuizing en andere onderdelen, in het geval van schade dient het speelgoed niet te worden gebruikt met de zender lader totdat de schade is hersteld.
- Voor de beste prestaties, gebruik altijd alkalinebatterijen. Om de batterijen te verwijderen, voer de installatieproce dure omgekeerd uit.

MEDEDELING VAN DE FABRIKANT

- Aanpassingen die niet door de fabrikant zijn goedgekeurd kunnen het recht van de gebruiker om het apparaat te bedienen teniet doen.
- Controleer dit speelgoed en alle accessoires regelmatig op mogelijke gevaren, en repareer of vervang onderdelen die mogelijke gevaren kunnen veroorzaken.
- Om te zorgen voor een betere kwaliteit en waarde, zijn we continu bezig met het verbeteren en bijwerken van onze producten.
- Derhalve is het mogelijk dat de foto's die in deze handleiding worden afgebeeld afwijken van het meegeleverd model.
- Gelieve alle informatie in verband met dit product bij te houden voor het geval u de informatie in de toekomst moet raadplegen.



14+ ZABAWKI DO UŻYTKU ZEWNĘTRZNEGO PRZEZNACZONE DLA DZIECI POWYŻEJ 12. ROKU ŻYCIA.



NIE DOTYKAĆ KRĘCĄCYCH SIĘ WIRNIKÓW.

DŁONIE, WŁOSY I LUŻNĄ ODZIEŻ NALEŻY TRZYMAĆ Z DALA OD WIRNIKÓW.

WAŻNE! Uważnie zapoznaj się z Instrukcją obsługi przed użyciem! Zachowaj instrukcję do późniejszego wykorzystania.

PRZESTROGA:

- NIE URUCHAMIAĆ I NIE LATAĆ KWADROKOPTEREM, JEŚLI W STREFIE ZASIĘGU JEGO LOTU ZNAJDUJĄ SIĘ LUDZIE, ZWIERZĘTA LUB PRZESZKODY (ZASIĘG LOTU: 50m).
- RYZYKO URAZÓW OCZU: NIE LATAĆ W POBLIŻU TWARZY, ABY UNIKNĄĆ URAZÓW.
- W MIEJSCACH Z WYŁADOWANIAM I ELEKTROSTATYCZNYMI PRODUKT MOŻE DZIAŁAĆ NIEPRAWIDŁOWO I WYMAGAĆ ZRESETOWANIA PRZEZ UŻYTKOWNIKA.

UWAGA!

Dron musi zawsze znajdować się w zasięgu wzroku użytkownika. Nie wolno wylatywać nim poza pole widzenia. Sterowanie dronem poprzez okulary wirtualnej rzeczywistości jest zabronione, jeśli użytkownik jest sam i przebywa na otwartej przestrzeni. Jeśli użytkownik chce sterować dronem za pomocą okularów, ktoś musi go nadzorować. Nie ma żadnych ograniczeń co do korzystania z drona w pomieszczeniach.

• Nieprzestrzeżenie ostrzeżeń bezpieczeństwa może stanowić naruszenie lokalnego prawa.



- Obsługiwać produkt i jego akcesoria zgodnie z instrukcją i jedynie po pełnym zmontowaniu!
- Zachować na przyszłość instrukcję obsługi.
- Przed pierwszym użyciem. Przeczytać instrukcję obsługi wspólnie z dzieckiem.
- Należy objaśnić obsługę oraz zasady bezpiecznego używania (zaleca się stosowanie ilustracji).
- Do latania kwadrokopterem wymagane są pewne umiejętności i dzieci muszą poćwiczyć pod bezpośrednim nadzorem osoby dorosłej.
- Sprawdzić, czy zabawka jest zmontowana zgodnie z instrukcją. Montaż należy wykonać pod nadzorem osoby dorosłej.
- Ten kwadrokopter może być używany tylko w pomieszczeniach – NIE na zewnątrz. RYZYKO URAZÓW OCZU.
- Startować i latać tylko wtedy, gdy obszar jest odpowiedni do zamierzonego zastosowania (wolna przestrzeń, bez przeszkód) i tylko w bezpośrednim kontakcie wzrokowym.
- Startowanie i latanie jest surowo zabronione w pobliżu stupów kolejowej trakcji elektrycznej, basenów lub otwartych zbiorników wodnych.
- Używać wyłącznie przy dobrej widoczności i bezwietrznych warunkach pogodowych.
- Produkt przeznaczony dla dzieci w wieku 14 lat i starszych.
- Prowadzić kwadrokopter w bezpiecznym obszarze, z dala od ludzi, zwierząt, samochodów itp.
- Nie należy dotykać kwadrokoptera, gdy jest w ruchu, ani nie próbować chwytania go w locie. Poczekać, aż znajdzie się w całkowitym bezruchu.
- Gdy kwadrokopter jest uruchomiony lub gdy nadajnik pracuje, należy trzymać włosy, palce, twarz i luźną odzież z dala od pracującego wirnika.
- Nie upuszczać ani nie uderzać kwadrokoptera i jego akcesoriów.
- Nie zmieniać, ani niczego nie modyfikować w kwadrokopterze.
- Nie należy samodzielnie demontować ani modyfikować kwadrokoptera oraz jego akcesoriów.
- Akumulatorki należy wyjąć z produktu przed doładowaniem.



UWAGA: BATERIE NALEŻY UTYLIZOWAĆ LUB WYRZUCAĆ W ODPOWIEDNI SPOSÓB.

Skontaktować się z lokalnym biurem gospodarki odpadami komunalnymi lub innej właściwej jednostki w celu uzyskania dalszych informacji.

- Upewnić się, że baterie są włożone z zachowaniem właściwej polaryzacji.
- Stosować wyłącznie baterie zalecanego typu (typów).
- Nie próbować zwierać, ładować, rozbiierać ani podgrzewać baterii.
- Nie moczyć ani nie wrzucać baterii do ognia.
- Nie należy używać jednocześnie baterii nowych i używanych, lub baterii różnego typu.
- Baterii jednorazowego użytku nie wolno ładować ponownie.
- Akumulatorki mogą być doładowywane wyłącznie przez osobę dorosłą.
- Wymianę baterii należy przeprowadzać w obecności osoby dorosłej.
- Przed odłożeniem produktu do przechowywania baterie należy wyjąć z produktu.
- Po użyciu należy wyłączyć urządzenie. Niezastosowanie się do tej instrukcji może negatywnie wpłynąć na baterie, prowadząc do uniemożliwienia ładowania.
- Zużyte baterie należy wyjmować z zabawki.
- Regularnie sprawdzać pod kątem uszkodzeń wtyczki, obudowy i innych części. W przypadku uszkodzenia zabawki nie wolno używać w pobliżu ładowarki przekaźnika, do czasu naprawy uszkodzenia.
- Aby zapewnić optymalne działanie, należy stosować wyłącznie baterie alkaliczne. Aby wyjąć baterie, należy postępować odwrotnie, jak przy wkładaniu.

UWAGA PRODUCENTA

- modyfikacje nie zatwierdzone przez producenta mogą unieważnić prawa użytkownika do używania urządzenia.
- niniejszą zabawkę i jej wyposażenie należy regularnie sprawdzać pod kątem ewentualnych zagrożeń, a potencjalnie niebezpieczne części należy naprawiać lub wymieniać.
- aby zapewnić jak najlepszą jakość oraz wartość, nieustannie polepszamy i aktualizujemy nasze produkty.
- dlatego też zdjęcia w niniejszej instrukcji mogą czasem różnić się od dołączonego modelu.
- Zalecamy przechowanie wszystkich informacji dotyczących tego produktu, tak by móc się do nich odwołać w przyszłości.

